



# Canuck In Denver's Emergency Preparedness and Survival Basics Guide



Basic information to get you started on the road to  
Emergency Preparedness and Survival - A beginner's guide.

By Canuck In Denver

© 2006 Canuck In Denver

and

SurvivalistsSite.com

[canuck@survivalistssite.com](mailto:canuck@survivalistssite.com)

[www.survivalistssite.com/~canuck/](http://www.survivalistssite.com/~canuck/)

This ebook may be freely posted on the internet, printed and handed out. You may not alter or edit any part of this ebook. You may not sell or profit from this ebook. All images are public domain.

Natural Disasters - Terrorist Attacks - Food Shortages  
Pandemic - Economic Collapse - Social Unrest  
**SurvivalistsSite.com**  
and many other situations threaten us

Natural Disasters - Terrorist Attacks - Food Shortages - Pandemic - Economic Collapse  
Social Unrest - Chemical Spills - Biohazards - Infrastructure Failure  
and many other situations threaten us.

In recent years there have been examples of many of these threats to ourselves and our way of life. From 9/11, to anthrax and bombs in the mail, to the Great Blackout of 2003, to the 2005 Hurricane Season and the destruction in the Gulf States, we have seen that these events are very real. We are warned daily of the potential for more terrorist attacks, of increasingly unpredictable and extreme weather, the possibility of a Global Pandemic and other emergencies with devastating effects.

We have become more aware that the world we live in is not a paradise where we may remain ignorant of the people around us and their intentions, the dangers inherent in our society and economy, or the havoc that nature can wreak upon us. We have seen that the government can not predict, plan, prepare or deal with emergencies; that we can not depend on government to make the correct or timely decisions and actions.

We are alone and can only depend on ourselves. That means that we must make plans, gather supplies and learn new skills so that we can cope with whatever emergency we may have to confront.

**Emergency Preparedness - Survival - Homesteading**

These are the buzzwords of our time. No longer are "Survivalists" seen as being on the fringe of society, with the government advising us to make plans and store supplies, "Survivalists" and "survivalism" have become main stream.

Don't you think it is time that you started making plans and learning how to prepare for and survive the emergency situations facing us all?

Emergency Preparedness and Survivalism cover a wide range of topics. This guide is not meant to answer all of your questions related to Emergency Preparedness and Survivalism, it is meant to be a basic guide to answer basic questions and to get you started. This guide should give you enough of the basics to get you started and to show that no matter how large a topic Emergency Preparedness and Survivalism is, that you CAN do it.

# Preface

I've been interested in survival since I was a kid growing up in the country. Surrounded by farms, trees, streams and all those things that made my boyhood fun... and dangerous. I've gotten caught in snap blizzards with zero visibility as a kid, obviously I lived to talk about it. I went hiking and camping with my friends and with my Wolf Cub pack when I was a kid. When I was older I went hiking and camping with my friends and with the Wolf Cub and Scout troop I was a leader of. I taught my Wolf Cubs and Scouts about survival and went beyond what was covered in the Scouts Canada manuals.

I've been on the survival newsgroups since 1996, as Canuck In Denver since 2000. I've visited hundreds of survival and emergency preparedness websites over the years. Many have come and gone during those years, but a few good ones have remained through it all. Every website has it's own feel and character, I think SurvivalistsSite.com is unique in that it offers anyone the chance to have a Blog or Community Page and is more of a community in that respect.

I guess you could say that I've been a survivalist for as long as I can remember. As a kid I always had a pocket knife, lighter, extra clothes and some food and water with me when I went anywhere. I knew how to build a fire, make a fishing pole and hooks and catch some fish to eat if worst came to worst, did I mention I HATE fish unless it is "Fish 'N Chips"? Part of the reason I always carried some gear was that with the exception of school I was as far away from my house as I could get, and living in the country that could mean trouble. We built shelters and all those things you need to live fairly comfortably in the wilderness, it was just what we did. Later in life once I had a car I always had some food, water, extra clothes, tools and spare parts for the car in the trunk. I became pretty good at working on my car. I developed more survival related skills when I spent time in the Society for Creative Anachronism and did medieval recreation for about 10 years... "primitive" camping with medieval technology taught me a few things.

This ebook is my attempt to give a little something back to all the people who have influenced my thoughts on survivalism over the years. You can find this ebook on my SurvivalistsSite.com Community Pages at [www.survivalistssite.com/~canuck](http://www.survivalistssite.com/~canuck) as well as individual downloads for the major sections, these are located in the "Downloadable Files" section. Some of the HTML pages under the "Emergency Preparedness and Survival Basics" section contain additional information not found in the individual file downloads or this ebook.

# Table of Contents

<b>Preface</b> .....	3
<b>My Thoughts on Survival</b> .....	5
<b>Getting Started - Survival Basics</b> .....	7
<b>Food &amp; Water Storage</b> .....	9
<b>Recommended BOB (Bug Out Bag) Contents</b> .....	12
<b>Basic Survival Tools</b> .....	15
<b>BOV (Bug Out Vehicle) Basics</b> .....	16
<b>Sanitation</b> .....	20
<b>Survival Shelter</b> .....	22
<b>Survival Weapon Basics</b> .....	32
<b>Mini Urban Survival Kit</b> .....	34
<b>Basic Pack</b> .....	41
<b>Sleeping Gear</b> .....	48
<b>Cooking Gear</b> .....	51
<b>Winter Clothing</b> .....	57
<b>First Aid and Medical Kits</b> .....	67
<b>Day Pack</b> .....	72
<b>Odds &amp; Ends - Miscellaneous Equipment and Clothing</b> .....	74

# My Thoughts on Survival

Somewhere while I was growing up I became a "survivalist". The idea of having food, clothes, gear and other things on hand in case things went wrong makes sense to me. Maybe it was my time as a Wolf Cub or my time as a Wolf Cub and Scout leader, maybe it is because I have always been a history buff, maybe it was the role playing games like Dungeons & Dragons I played, maybe it was a combination of these and my innate personality. Who knows? I sure don't. All I know is that it makes sense to have those supplies.

To me, survivalism is not like Mel Gibson in Mad Max or the Road Warrior or any number of Hollywood versions of what happens after the crap hits the fan. Survivalism can best be illustrated by those few people in New Orleans in 2005 who made it through hurricane Katrina with little difficulty. By having a supply of food, water and a means to cook they were able to stay in their homes until government agencies could get their act together and start bringing in relief supplies.

When you get right down to it, survivalism is what our parents, grandparents and great grandparents practiced on a daily basis. They always had food in the cupboards just in case something went wrong. If they lived in a rural area they had gardens, canned, had root cellars and lots of firewood. They knew that you need to have food in case you can't get to the store. They knew you had to have light and heat in case the power went out.

At the core of survivalism is the desire to be prepared for whatever man or nature throws your way. It could be weather related, I lived 60 miles away from Buffalo, NY during the blizzard of 78 and as a kid thought that a week of being completely snowed in and then another without school during my favorite season of the year was great. It could be "man made" such as a chemical spill. It could be having no power for two weeks for whatever reason. It could be a disruption in the distribution system used in today's "just in time" delivery method for store stocking - when was the last time you went to the grocery store late Sunday and found that many items were out of stock - what if no trucks could get through for a week or more? There are any number of events that can throw a monkey wrench into your day-to-day routine that could affect your very survival.

Part of survival includes knowing what emergencies or disasters you are may experience. Do you live near a busy highway that hazardous material trucks use? Rail road tracks? Is there a chemical plant near by? What about a nuclear reactor (power company or university)? What about forest fires? Floods? Tornadoes? Hurricanes? Winter blizzard? If you live in a city you may have to deal with civil unrest and rioting. Some people have moved from the city to the suburbs, some have moved to a more rural location. Others prefer to have a cabin or some other sort of retreat to go to in case the crap hits the fan. Some plan on going to a friend or relative's. Every person's situation is different and requires different plans and gear. You must assess your situation, your means and make some plans. Regardless of your particular situation there are a few constants in every emergency, disaster or survival situation.

## **Riding out the emergency or "Bugging In"**

There are any number of simple things the average person can do to make their chances of surviving such an event as easy and assured as possible. Simple things like having at least two to four weeks of food on hand. The more food you have the better. This food should be easy to prepare and require no refrigeration. Canned, dried, "heat and eat" foods (MREs, boil in the bag, etc) are great for this and do not require a lot of room. Water, at 3 gallons a day per person just for food will take up more room, but between water on hand and some way to purify the water you should be able to survive on two to three days of stored water. I'd also increase the amount you store per day to 5 gallons per person per day, water jugs usually come in 5 gallon sizes. If you are going to pack freeze dried food that needs to be rehydrated you will need to stock more water, which is another reason to round up to 5 gallons per person per day.

Water can be stored as store bought bottled water or in bottles or drums that you fill yourself and treat with a few drops of regular chlorine bleach, or a combination of the two. Water purification should also be considered as in most cases when municipal water is once again available it comes with a boil and/or treat advisory. A gravity filter such as a Berkey or Katadyn makes this process much easier. Water purifiers also allow you to use water from just about any source you may find... stream, pond, lake, etc. Smaller gravity filters can be taken with you in the event you have to evacuate your home.

There are a number of other things you can do to make life at home easier in an emergency situation. If you have a fireplace make sure you have wood to provide heat, you may also want to consider a stove insert that will allow you to cook food on the top in pots and pans. You may want to consider a basic wood burning stove such as a pot bellied stove for the kitchen for heat and cooking. Candles, candle lanterns, oil lamps, battery lanterns, camping lanterns and solar rechargeable deck lanterns

can all be used around the house to provide light. Camping stoves can be used to cook on as can gas or charcoal grills. Charcoal fire pits can be used inside to provide heat (and to cook on), similar items were used in the past and are called braziers. Propane or kerosene heaters can also be used to heat your house.

I like charcoal. I have three charcoal grills, your standard Weber kettle grill, a small Hibatchi, and a large Brinkman (will also burn wood) that has two cooking areas and can fit 72 beer brats on both sides. The Brinkman will stay hot for about 4 hours with ten pounds of charcoal. Charcoal is fairly cheap, I pay about \$11 for two 40 pound bags of Kingsford at Sam's Club, and with a charcoal fire pit or improvised brazier I can use it to heat the inside of the house if worst comes to worst.

Keep in mind that anything that burns indoors presents a fire and carbon monoxide hazard, get a couple of battery operated carbon monoxide monitors and keep them with your emergency supplies. Make sure you open a couple of windows an inch or two to allow ventilation. These should be in addition to any carbon monoxide detectors already in your home, make sure you have extra batteries.

If you have a lot of frozen and refrigerated food or have medical equipment that requires electricity you will want to think about a gasoline, propane/natural gas or diesel powered generator. Gasoline powered generators are by far the most common, but gasoline should not be stored for too long. Propane powered generators are usually found as whole house backup generators due to the clean burning propane/natural gas and the long term storage capabilities of propane/natural gas, but can be found in portable models as well. Diesel generators are less common but they are more durable than their gasoline counterparts, diesel also has storage issues but can be stored longer than gasoline (not to mention bio-diesel). In some cases you can find dual or triple fuel generators that run on a combination of liquid and LP (low pressure - propane/natural) gas. With generators in every size from small 1 kilowatt Hondas and up, there is a generator to meet every need and budget.

Without water service or electricity (to pump the water) you will not have the ability to flush your toilet. A portable toilet of some sort will come in very handy. This can be a basic five gallon pail with toilet seat attached and garbage bags to a sawdust toilet or ready made portable toilets.

That about covers the various things an average person can do to make staying at home during and after an emergency that disrupts normal services. It goes without saying that you should have the basic tools most home owners do, a shovel, axe, saw, hammers, etc to make any basic repairs that are needed, such as boarding up windows after a hurricane or clearing downed trees.

### **Evacuating your home or "Bugging Out"**

You should also have a BOB or Bug Out Bag for every member of your family in case you have no option but to leave your home. Your BOB should contain food, water and clothing for three days to a week. You should have some means to purify any water you find. You should have basic cooking gear, sleeping gear, personal hygiene and first aid supplies, basic camping tools, shelter and some means to listen to the news. Don't forget basic identification and proof of where you live and copies of any other important papers. Your BOB should be packed and ready to go at all times.

When the need or order to evacuate comes the first thing you should do is get in contact with all of your family members. Next put your bug out bags in your vehicle; if there is time, load up with all the extra food, water, clothing and other gear you can safely fit into your vehicle. Getting your bug out bags loaded into your vehicle should take no more than five minutes if everyone does it at once. Keeping a few plastic storage totes and a luggage cart can aid in moving other items like cans from your cupboards and pantry and any stored water you have. A few five gallon water jugs can be quickly filled then loaded. From the time you are notified or decide to evacuate should take no more than 30 minutes in an ideal situation.

If you have the money and the room, you may want to consider getting a small trailer to tow behind your vehicle. Generally your vehicle can tow more than it can carry. If you have a small trailer you can keep most of your gear stored in the trailer with the exception of any temperature sensitive items like canned or perishable food, freeze dried food is generally fine in a trailer. With a trailer all you have to do is hook it up, load your bug out bags and any extra food or gear and leave.

You should have a plan in place in the event leaving your home is required. This should include meeting places, a number of destinations depending on how long you expect to be away and several routes out of the area you live in and to your destination. If at all possible do not take interstate or large highways, these will quickly become packed with cars as people leave. Use back roads and round about routes if you have to, have alternate routes marked to get around any bottlenecks along your route. The sooner you leave the less traffic you will encounter and the less time it will take you.

# Getting Started - Survival Basics

If you are new to survival or emergency preparedness you are probably a bit overwhelmed at all of the information out there. You're probably also wondering if there is a "Dummies Guide" or a single resource for what you will need to know. Although there isn't a Dummies Guide there are a few good books for people who are just starting out. There are also lots and lots of sites on the web with loads and loads of information and ideas.

On the book front the two main books are the US Army Survival Manual FM 21-76 available from Barnes & Noble for about \$9.00, \$10 in hard cover. There is a new/current version of the US Army Survival Manual FM 3-05.70 that I have only seen in online versions, a PDF version is available in the Downloads Section of the SurvivalistsSite.com Message Forums (Members only).

The second book is the SAS Survival Survival Guide, with the Collins Gem pocket size being the most preferred due to its small size. The Collins Gem version of the SAS Survival Guide will have a new edition available at the end of February 2006, ISBN 006084982, and is about \$8.00. Most people in the survival community list these as the two best survival books out there, along with older versions of the Scouting books.

Next on my list is Dare to Prepare by Holly Deyo. Dare to Prepare is a huge 500+ page 8.5x11 inch format book that is written for the average person. It is available directly from Stan and Holly Deyo for about \$40.00. I call Dare to Prepare the book of lists, it has lists for everything and lots of basic information on emergency preparedness and survival. If you go to [www.standeyo.com](http://www.standeyo.com) you can see the table of contents and just how extensive it is.

I have copies of the US Army Survival Manual, the SAS Survival Guide (Collins Gem edition) and Dare to Prepare. If I have to bug out my copies of the US Army Survival Manual and the SAS Survival Guide will be going with me, they are packed in my BOB (Bug Out Bag), Dare to Prepare will go with me if I remember to grab it off the shelf next to my gear. I really can't recommend the SAS Survival Guide enough, I have owned a copy for years and just pre-ordered two copies of the new Collins Gem edition... and I'm thinking of adding a third to the pre-order. I won't recommend something unless I own it and find it useful... or it receives lots of really good reviews... or it is on my need to get list.

Well there you have it, the basic books that are most often recommended and the one I think is probably the best place for new people to start out with.

Now for some practice background information to get you started. What comes next is my thoughts on survival basics, the things that are common to just about every possible emergency, and from which comes everything else. When learning any new skill there are a few key areas that form the core of the skill, the basics. Below are what I consider the basics, enough to serve you well in any situation and enough to get you started. Once you understand the basics and the thought processes involved you will be comfortable with other concepts or areas of survivalism.

There are four main sections to survival or emergency preparedness - Food, Water, Shelter and Planning. There are other sections to survival, but these four are the basics. I will touch on the other more advanced areas near the end.

## **Food**

Without food you will die, it is as simple as that. You need to eat. You need to have food on hand in case an emergency happens. People in the survival community usually talk about "rotation" or "rotating" when they talk about food you have stored. This means eating the food you have stored before it goes bad and replacing what you have eaten with new items. What food you choose to store, and for how long is a personal choice. Having at least enough for one or two weeks is the minimum suggested amount. Some people store enough food for a year or several years. For more information on food storage see [Food & Water Storage](#).

## **Water**

Again, without water you will die. You need water to cook with, to clean with and to wash with. Most people in the survival community suggest 3 gallons per person per day, I suggest 5 gallons per person per day to allow for extras and for the ease of calculating how much you need. There are lots of ways to store water, or purify water, etc. See [Food & Water Storage](#).

## **Shelter**

Without shelter you will die. This "without x you will die" is really starting to get old, isn't it? The simple fact of the matter is

that it really is true. You need shelter from the elements, just as you need food and water. What your shelter happens to be in a survival situation is going to depend on a lot of factors. If you always have your own shelter with you then you will never have to worry about keeping the rain off your head or having a dry place to sleep. Shelter can be anything from your house, a travel trailer, a tent, to a cabin or cave. A small tent or a couple of tarps and some rope will give you shelter when you need it and do not weigh much.

### **Planning**

Planning is the big part. You have to know what kinds of emergencies may happen to you. Every town and geographic area has its very own potential emergencies. From weather and natural disasters to chemical spills and other man made hazards there are at least three facing any one of us. We usually don't think about them, but under the right circumstances what we don't think about can and will kill us. The first thing we have to do is perform a "threat analysis" and see what potential emergencies there are for us in our area. Then we have to plan what food and equipment we will need to survive those emergencies.

In some cases we will be able to remain in our homes to ride out the emergencies. In others we will have to evacuate our homes, this is where having portable gear is a must - you need to be able to get on the road and get out as fast as possible, there is no time for getting everything from the grocery and department stores. A portable kit is usually called a BOB (Bug Out Bag), for more information on BOBs see BOB Basics. If you don't have what you need then it is too late. Stopping at a grocery or department store to get extra supplies is one thing, waiting until the last minute to get basic supplies can get you killed.

If you need to evacuate you will need to know what routes out of your city or town there are. You will want to have multiple routes to take depending on where you are going and in what direction. You may have to take a round about way to avoid traffic jams, etc. You will want to know interstates, state highways, back roads, etc so that you have every option open to you. Mark these on maps you keep with your gear; you want local, state and national maps; and you want to at least drive the routes out of your city or town for a few miles so that you don't have to look at your maps in the event you have to evacuate or bug out.

### **Advanced**

The more advanced aspects of survivalism include having a dedicated BOV (Bug Out Vehicle) and/or trailer that is kept loaded and ready to go; for more information on BOVs see BOV Basics. Some people have survival retreats that they intend to go to in the event that they need to evacuate or bug out. Some people store seeds and gardening/farming tools so that they can grow their own food in the event of a long term emergency or survival situation. In most cases people store what are called "heirloom" seeds, these are older non-hybrid varieties of seeds that produce fertile seeds that can be used year after year versus many hybrid seeds in which the crop does not produce fertile seeds.

Many people start gardens where they live now, plant fruit trees, etc. Some plant fruit trees at their retreats and/or gardens in addition to the ones at their homes. Usually retreats are a country cabin, in some cases it may be land as far away from civilization as possible and includes a hidden shelter (cave, buried house, etc) and buried or "cached" supplies. Some people also bury caches of gear along the route or routes they are likely to take to get to their retreat or bug out destination.

Some people practice what is called homesteading, which are small farms that are as self sufficient as possible. Many people live "off grid" which means they live without electricity in some cases but usually means they have some means to produce their own electricity or use alternatives to electrical appliances. Wood burning stoves and water heaters are often installed in houses to provide cooking, heating and hot water. Gas, diesel and propane powered generators are often installed to provide electricity when the power goes out.

Some people store lots of guns and ammunition. Some people learn to make their own bows and arrows along with other older skills that are not common in today's world. Most experienced survivalists use a number of the skills and ideas without going to extremes.

Most survivalists have more in common with our parents, grandparents and great grandparents in their daily lives than they do with modern families. They raise at least some of their own food and then can it, they have pantries full of food, have firewood split and ready to burn, and are ready in the event that anything does happen. They can get along just fine without having to run to the grocery store everyday or going to a fast food joint, and find power outages inconvenient at most. They are prepared to stay at home in the event of an emergency while also being ready and able to leave their homes if that is what is required.



# Food & Water Storage

## Food

Much has been written on food and water storage, especially food. Water is fairly straight forward and will be dealt with second.

On the topic of food there are a variety of ideas, from 50 pound bags of wheat and dried beans, to MRE (Meals Ready to Eat) rations that the US military eats when in the field, to commercially packaged retort pouches, to freeze dried or dehydrated, and finally to what you eat on a regular basis. Each idea has its merits and its drawbacks.

Wheat and dried beans (includes bulk rice, flour, etc) are great due to their inexpensive cost, but if you don't like wheat or dried beans or won't eat them then there is no sense in spending the money. Wheat and dried beans can be used as a supplement, or for trading, in addition to your primary food source. Keep in mind that any radical change in diet or foods eaten can have negative side effects on your body... you had better have a lot of toilet paper and Pepto.

MREs are relatively lightweight, come in many choices and can be eaten hot or cold. They are high in sodium, heavier than freeze dried/dehydrated and can be expensive and hard to find. They are great to have in your pack, BOV or pantry when you need something quick.

Freeze dried/dehydrated foods are very lightweight, have a fairly long shelf life, come in many choices and are great when weight and space are at a premium. Some meals are better than others, so try one before you buy a case. They also require water, which means you will have to have more water than the basics of 3-5 gallons per person per day. They are also more expensive than regular canned goods.

This brings us to "what you eat on a regular basis". This is my preferred primary storage food. Being in the middle of an emergency or crisis situation is no time to be experimenting with foods you are not use to. It is also the cheapest way to buy food. I know how much of a given item we use on average in a week. If that happens to be 3 cans of kernel corn then I know that I need 12 cans for four weeks or 156 cans for a year. Nice and basic.

The first thing to do is keep a small notebook with you when you go shopping. For a month you will write down every item you buy or use and how much. If you are buying or using fresh produce estimate how many cans it would equal. If you are buying or using meat estimate how many pounds it would equal.

When you have your list for the month go through your cupboards and pantry and write down the spices, baking items and condiments you use. Sit down with your family and go over the list to see if anything was missed. This is the time when those items you rarely use are added to the list, figure out how much of that item you will need for the period of time you are planning on storing food for.

Once you have a list of everything it is time to figure out the amounts for each item on your list. You want numbers for a week, a month (4 weeks) and a year (52 weeks). This allows you to be flexible in your purchasing, you can buy items in one week increments or if in multi-packs you easily know how many weeks it supplies.

Comfort foods and snacks should also be included in your food storage. In times of high stress a Twinkie or cookie can often help calm you down, make things seem more normal, and lets face it... it is nice to have a little treat every now and then.

## Water

It is a little easier to figure out how much water you need. Government generally suggests 1 gallon of water per person per day. This is a MINIMUM amount. More realistic numbers are 3 gallons per person per day for food, bathing, cleaning, etc. Three is a bit of an odd number though. Most water containers come in increments of five, 5 gallon water cooler jugs, 5 gallon water jugs, 10 gallon water cooler jugs, etc. Because of the five gallon increment in most water containers I suggest 5 gallons per person per day, or 35 gallons per person per week, for ease of calculating amounts and it allows an extra margin for the unseen things that always come up.

What you store your water in offers a wide variety of choices. Water cooler jugs stack well, and you can buy hand pumps to get the water out. Cases of bottled water also stack well, but mean smaller containers. One gallon water jugs can be placed on shelves, stay away from some of the cheaper brands that have poor sealing (Wal-Mart brand is one example) or thin jugs.

Most commercial water bottlers say that once sealed their water has an indefinite shelf life, despite the "best before date" mandated by law.

Many people choose to store their own water, some in 55 gallon water barrels, some in 2 litre pop/soda bottles. To do this you need to add some plain chlorinated bleach to each container before sealing. Because chlorinated bleach loses its effectiveness over time some people use granulated chlorine available from pool supply stores which has a longer shelf or effective life. You should check the quality of the water every 6 to 12 months if you choose to store your own and use bleach.

If you do not have a lot of room to store all the water you want (1092 to 1820 gallons per person per year - 3 to 5 gallons per day) in your house or garage then you need to have other options. Some people build water cisterns on their property and then filter drinking and cooking water from that. Others may choose to use a large water storage tank such as the 1500 gallon one available from Northern Tool and other supply companies such as [www.watertanks.com](http://www.watertanks.com). The other option is to have a good gravity based water purifier. The Berkey series and the Base Camp by Katadyn are two of the many options out there to purify your water before use.

Having a gravity based water purifier allows you to store less drinking and cooking water and allows you to use whatever water is available from your surroundings. Extra filters for the water purifier should be stored per manufacturer's guidelines and can be sealed with a vacuum sealer.

### Logistics of Food Storage

Storing food can take up a lot of room depending on what type of food you choose to store. Bulk items like grains can be placed in metal or heavy plastic 55 gallon barrels or drums to keep pests out. They can also be stored in 5 or 6 gallon pails. In either case make sure that the container is food grade or you run the risk of pesticide or other toxic substance residue left over from previous use. There are also stackable plastic containers available made from food grade plastic from Gamma Plastics, don't let the pet food label scare you... food grade is food grade. I have a couple of the large 60 gallon stackable ones (holds 100-125 pounds of sugar).

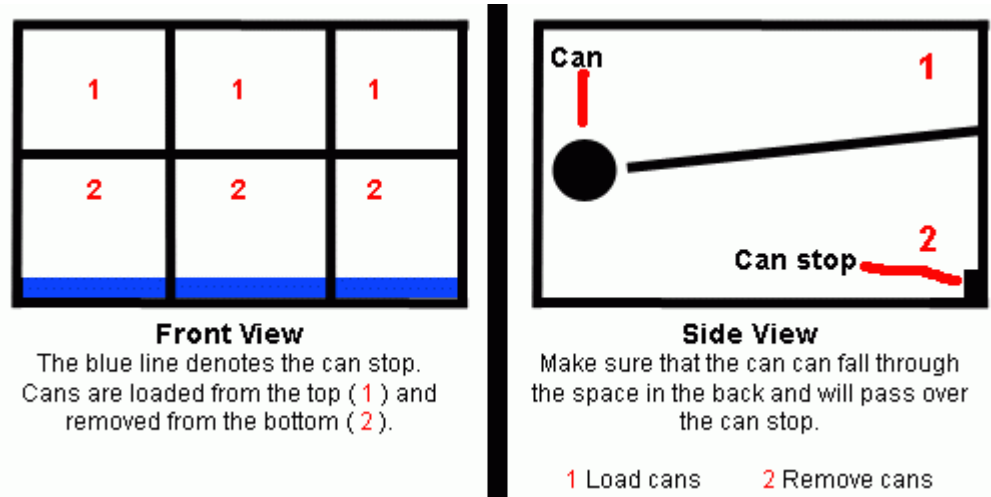

Keep in mind when storing food that not all foods are temperature insensitive, extremes of heat and cold can reduce the shelf life of foods. Moderate cold temperatures, 40 to 50 degrees F or 5 to 10 degrees C can actually extend the shelf life of foods.

When storing food you should mark the month and year of purchase on the container with a permanent marker or grease pencil. This allows you to know when the food is at its best, many foods are still good past "best before" dates but may lose nutrients or have a bland taste.

If you are storing cans you can stack them on shelves, but this makes rotating your food more difficult. You can build can dispensers, like those sold for keeping soda/pop cans in refrigerators, that will allow you to easily add and remove cans. The oldest cans are always closest to the bottom and the newest close to the top. You can size the dispenser for different diameters of cans easily once a few measurements are taken. If you are storing lots of similar diameter cans you can make wide dispensers with adjustable dividers. To the left are a couple of rough pictures of a can dispenser.

### Other Thoughts

Make sure that you have a few manual can openers with your canned foods. You may also want to store multi-vitamins to make up for any loss of nutrients from older food and to make sure that you and your family are getting the right vitamins and minerals. If you are going to store powdered milk you will find that most of available brands use no-fat, low-fat or 2%, in

the Mexican food aisle you can find powdered milk that is whole or approximately 4%. You may also want to consider Coast Guard approved survival rations such as the Datrex or Mainstay available from Nitro Pak and other suppliers.

There are a number of traditional and web based retailers and direct suppliers of MREs and freeze dried/dehydrated products. Two of the largest web based companies are Nitro Pak and Ready Reserve Foods. Brands such as Mountain House and AlpineAire being the most common online and in traditional stores.

### **Summary of Food Storage Options**

MRE's - Shelf life of up to 10 years, relatively light weight, complete meals. Great for short term (2-4 weeks), for backpacks or BOBs and whenever you want a quick meal. Can be expensive.

Freeze dried/dehydrated - Light weight, long shelf life. Great for backpacks or BOBs. Can be expensive, requires extra water.

Store what you eat - Easiest on your system, inexpensive, easy to get. Heavy, shorter shelf life.

Wheat and beans - Great basics, cheap. Can have a long shelf life. Requires you to get containers, may cause problems due to diet change, more work.

In the end a combination of the four main categories is probably best. MREs and freeze dried/dehydrated are great for when on the go or you want something quick. Canned foods that you already use the most common, easiest to get and cheapest make the best overall choice/primary source. Bulk wheat and beans will last for a long time, Egyptian tombs have shown shelf life of thousands of years, are very cheap, and can be used to trade with other people.

### **Links to Manufacturers and Suppliers**

Mountain House	<a href="http://www.mountainhouse.com">www.mountainhouse.com</a>
AlpineAire	<a href="http://www.alpineaire.com">www.alpineaire.com</a>
Ready Reserve Foods	<a href="http://www.readyreservefoods.com">www.readyreservefoods.com</a>
Freeze-Dry Foods	<a href="http://www.freeze-dry.com">www.freeze-dry.com</a>
HeaterMeals	<a href="http://www.heatermeals.com">www.heatermeals.com</a>
Long Life Food Depot	<a href="http://www.longlifefood.com">www.longlifefood.com</a>
Nitro Pak	<a href="http://www.nitro-pak.com">www.nitro-pak.com</a>
Sopakco	<a href="http://www.sopakco.com">www.sopakco.com</a>
Walton Feed	<a href="http://www.waltonfeed.com">www.waltonfeed.com</a>
Wornick	<a href="http://www.wornick.com">www.wornick.com</a>
Ameriqua	<a href="http://www.ameriqua.com">www.ameriqua.com</a>
Northern Tool	<a href="http://www.northerntool.com">www.northerntool.com</a>
WaterTanks.Com	<a href="http://www.watertanks.com">www.watertanks.com</a>
Berkey	<a href="http://www.berkeywater.com">www.berkeywater.com</a>
Katadyn	<a href="http://www.katadyn.com">www.katadyn.com</a>

# Recommended BOB (Bug Out Bag) Contents

## FOOD & WATER

- 3 to 10 days of lightweight food
- At least 2 days of water
- Means to purify water
- Some way to cook your food (stove, rack for fire)
- 1 quart pot, 3 quart pot, stainless steel fry pan, coffee percolator/tea pot
- stainless steel mess kit, two insulated or plastic mugs/cups
- knife, fork and spoon set, steak knife
- 5 gallon collapsible water jug
- measuring cups, spatula, slotted spoon
- basic spices
- 2 quart canteens, water bottles or hydration bag
- dish scrubby and dish soap
- small bottle of bleach
- manual can opener

## SHELTER & SLEEPING

- tent with extra pegs/stakes and/or two tarps (8 feet X 6 feet)
- sleeping bag or blankets
- sleeping pad
- 10 to 20 small nails
- 50 feet of rope
- 100 feet parachute cord
- plastic sheet/tarp or heavy duty garbage bags

## CLOTHES

- underwear, 4 to 7 pairs
- socks, 4 to 7 pairs (wool - some cotton is OK)
- T shirts, 4 to 8 (at least 2 all synthetic)
- long sleeve shirt
- fleece or wool sweater or 2
- wind & water resistant jacket with hood
- athletic/sweat pants, 2 pairs
- jeans, 1 pair
- shorts, 1 pair
- thermal underwear, 1 pair
- watchmens cap (wool or fleece)
- baseball cap
- sneakers
- hiking boots
- water shoes, moccasins, flip flops, etc
- army poncho
- seasonal clothing
- Woolite
- retractable clothesline and clothes pins (6 to 10)
- bandannas (3)

## BASIC TOOLS

- Multi-tool (Leatherman, Gerber)
- folding knife, 3 to 4 inch
- fixed blade knife, 4 to 6 inch
- hatchet
- machete
- leather work gloves

- compass
- LED flashlight
- squeeze/shake/windup LED flashlight
- light sticks, three 6 hour
- solar/crank/battery powered multi-band radio
- whistle
- matches, 50 to 100
- disposable lighters, 2
- magnesium fire block
- binoculars, small sportsman's
- small shovel or entrenching tool
- basic survival kit

#### **FIRST AID & MEDICAL**

- basic first aid kit
- blister cream and moleskin
- NP95 disposable masks
- latex exam gloves
- medicated foot powder
- extra Ace bandages
- spare eye glasses or contacts
- 30 day supply of any prescription medications
- lip balm/chapstick
- sunscreen
- 2 decks of cards (Sanity)
- favorite book (Sanity)
- travel/auto versions of popular games (Sanity)

#### **PERSONAL HYGIENE**

- comb/brush
- tooth brush, tooth paste, floss
- deodorant/antiperspirant (scentless if going into woods)
- nail clippers & file
- soap in soap dish and/or liquid soap
- face cloth or body scrubber
- hand towel
- bath towel
- baby wipes
- baby powder
- sample/hotel size shampoo and conditioner
- antibacterial wash
- sample size shaving cream and disposable razor
- toilet paper
- small unbreakable mirror
- feminine products
- garbage bags

#### **MONEY, ETC**

- roll of quarters
- pre-paid long distance phone card
- Cash, as much as possible in 1s, 5s, 10s & 20s (minimum \$200)
- Keep in mind bribes and other "tolls" or "taxes" that may suddenly appear
- ID, copies of important papers

The minimum amount you will need is the number of gallons of gas it takes to get to your destination times \$5 (to account for price gouging), plus meals and snacks along the way and hotels based on one room for every 12 hours of travel time plus one more just in case.

## **THE BUG OUT BAG ITSELF**

Your BOB should be made of sturdy material. It can be a backpack, duffel bag or a plastic tote. I would suggest a backpack so that it is easy to carry if you are forced to walk for any distance. Older ALICE backpacks allow you to add pouches, canteen covers, etc and are fairly inexpensive.

## Basic Survival Tools

In any survival situation there are a number of tools that will help you recover from a disaster, whether that is rebuilding, cleaning up or getting your BOV unstuck. Ideally you should have a set of these at your retreat if you have one and a set on your BOV. If you can only afford one set keep it with your BOV or in your trailer. If space is a premium in your BOV consider a large roof basket and build a box to put in the basket and keep these tools in. These tools could mean the difference between your BOV remaining stuck, or how easy your cleanup or rebuilding is. With the exception of the chainsaw you should be able to get these tools for between \$100 and \$200, a small price to pay for being well prepared for whatever comes your way.

These tools are on top of the basic tools we all have - hammers, screwdrivers, sockets, wrenches, gardening and woodworking tools, etc. Below are some of the common tools you can get at any hardware store. For less common, or old fashioned, tools that would be good to have if you are forced to rebuild from scratch with no power sources see Lehman's.

When trying to decide between wood or fiberglass handles I usually choose wood. Fiberglass handles quickly raise the price, but are known for being near to unbreakable, lighter and longer lasting. If you decide to go with fiberglass handles make sure that the handle can be replaced and that the tool in question is not moulded with the fiberglass handle. You may also want to consider picking up a wood replacement handle as well.

- Shovel, round, long handle (Since these are so useful you might want to get 2.)
- Shovel, round, short handle
- Shovel, spade
- Shovel, square
- Dirt Breaker
- Pick
- Axe
- Hatchet
- Bowsaw
- Machete
- Splitting wedge
- Sledge, 4 pound
- Sledge, 10 pound
- Prybar, 36 inch
- Fork
- Hoe
- Rake, bow / gravel
- Rake, leaf
- Bolt Cutters, 24 or 36 inch (To cut fence or chain while bugging out.)
- Chainsaw (To quickly cut any fallen trees blocking your path while bugging out.)

# BOV (Bug Out Vehicle) Basics

There are three schools of thought or approaches to BOVs:

The first school is the traditional BOV, a pre-1980 4x4 pickup or SUV, this school of thought advocates these earlier vehicles primarily for their supposed resistance to the effects of EMP (Electromagnetic Pulse) from a nuclear weapon or other source. The theory is that older vehicles that have less electronics on them will survive EMP better than newer vehicles. Another side consideration is the lack of tracking systems such as Onstar and immunity from new devices that would allow the police (or someone else) to turn the vehicle off by using some sort of directed energy weapon (these are real although in the early stages and may not be in use anywhere).

The newer vehicle school of thought says that the likelihood of a detonation of a nuclear bomb that will produce EMP happening is slim to none, and there is no hard evidence that older vehicles will not be affected or that newer vehicles will be affected by EMP, so you might as well use a modern 4x4. This school also points out that modern vehicles have better fuel economy than older vehicles, and they're a lot nicer to be in on long trips.

The third school of thought is the use whatever you have school. This school of thought realizes that not everyone can afford a dedicated BOV or that they can not afford to buy another vehicle. For options in this area see my blog article on [Bug Out / Evacuation Cargo Carrying Options](#) and Blackstar's blog article on [Survival Transportation - Small & Midsize cars](#).

I am going to deal with what a BOV should be in an ideal situation. This will apply to the first two schools of thought and I will not advocate one or the other. There is information below, tools and spare parts, that will apply to all BOVs.

A BOV should be or have the following features:

- 4x4
- large enough to fit your family, pets and your core gear
- have a trailer hitch - receiver style (a front mounted hitch receiver is also a good idea)
- have at least one winch, two would be better (front and back)
- be in good repair and running condition
- have upgraded shocks or springs (better towing and cargo capabilities)
- have a brush guard
- have at least one full size spare
- a cargo basket or roof racks on the top (increased gear storage)
- have driving and fog lights
- largest tires possible
- skid plates (front minimum - transfer case and drive line advisable)
- gas tank protection (skid plate)
- have a good CB and antenna (full size steel whip antenna with spring at base)

For some people the BOV of choice will be a full size pickup, a full size SUV, a small/midsize pickup or a small/midsize SUV. This will depend on a lot of factors including the size of their family, their budget and their needs. There are lots of options out there to meet the "minimum" requirements listed above. The upgraded shocks or springs are a simple and fairly inexpensive upgrade that can be done by the owner or a mechanic. Brush guards are also fairly inexpensive and can be installed by the owner or a mechanic and allow the mounting of a winch and the driving and fog lights. A rear mounted hitch could require the addition of a custom bumper, although there are commercial bumpers available for some vehicles, plus there is the option of mounting the winch to a custom 2 inch receiver tongue. Some people in the 4x4 community carry tubes for their tires in case a hole is too large to patch or plug on the trail, some pre-mount the tube inside the tire so all they have to do is pump it up.

You want to make sure that your fan shroud is in good condition as it is one of the most important items under the hood. This piece of plastic serves two major functions, the first is the guiding of air through the radiator to provide sufficient cooling (very important when hauling a full load) by limiting turbulence around the fan. The second is that it keeps the spray of water over the engine and electrical systems reducing the chances of stalling the engine out due to excess water spraying the ignition system.



For those looking to buy an older fullsize pickup or SUV they can often be found in good mechanical and body condition for \$2000 or less. If you are not mechanically inclined you will want to take it to your mechanic to have it looked at and get any marginal parts replaced. It is better to be sure than to break down halfway to your destination. You don't need a monster truck, you need a basic 4x4 truck that will get you to where you are going.

Even if you are not mechanically inclined there are a number of basic repairs that any person can do as long as you have the repair manuals and some basic tools. Not only will you get to know your vehicle better but you will save yourself some money by doing the routine things. When buying repair manuals I always get both the Chilton's and the Haynes manuals.

Your BOV should always have the following items in it:

- repair manuals
- basic mechanics tool set
  - standard and metric socket set
  - standard and metric wrench set
  - ball peen hammer
  - torque wrench
  - channel lock pliers
  - locking pliers
  - linesmans pliers
  - needlenose pliers
  - adjustable wrenches (6, 10 & 15 inch)
  - screwdrivers (3 flat head & 3 phillps)
  - torx set
  - allen wrench set
  - spark plug socket and setting tool
  - distributor wrench
  - wire stripper/crimper
  - electrical connectors and wire
  - basic voltmeter or circuit tester
  - electrical tape, shrink tubing, cloth friction tape
  - WD-40 or other spray lubricant
  - duct tape
  - flashlight
  - breaker bar
  - RTV sealant and/or gasket maker
  - tarp
  - super glue and paper clips
  - JB Weld
  - starter fluid
  - degreaser
  - can of contact cement
  - Knipex pliers (for gripping rounded nut or bolt)
  - nylon zip ties
  - jack stands
  - assorted nuts, bolts and washers for your vehicle
  - other specialty tools required for your vehicle (usually on Fords)
- spare set of fuses
- spare set of all bulbs
- spare hoses
- spare spark plugs
- spare spark plug wires
- spare wiper blades
- fluids (oil, transmission fluid, power steering fluid, coolant/antifreeze, etc)
- tire repair kit including fix-a-flat or "slime"
- lug wrench/tire iron
- flares or reflective triangle
- jack (Hi-Lift or bottle)

- "come-a-long", 2 ton (manual hand winch type tool)
- snatch block
- jumper cables (quality all copper 4 or 6 gauge)
- air compressor
- rags
- waterless hand cleaner
- snow brush
- squeegee
- tow chain
- snow chains (good for mud too)
- traction aids (carpet, sand, board, etc)
- distilled water (for battery)
- stop leak for radiator, oil, etc
- HEAT/Dry Gas
- octane boost/gas treatment
- at least one 5 gallon gas can
- drinking water
- leather work gloves
- change of clothes
- spare boots/shoes
- first aid kit
- baby wipes
- toilet paper
- some freeze dried/dehydrated food
- blanket
- coat
- poncho
- rope
- multi-tool (Leatherman / Gerber)
- maps of city, state and country
- candles or fake fireplace log
- matches or disposable lighter
- trash bags
- cooler (to keep food and water in)
- water purifier (Katadyn or Berkey) or purification tablets
- seasonal items (clothing, etc)
- oil filter

In addition to the spare parts listed above you may want to carry some of the more common and easy to replace parts below:

- ignition coil
- alternator
- thermostat
- complete distributor or at least cap, rotor and points (for older vehicles)
- starter
- U-joints
- voltage regulator (older vehicles)
- fuel pump
- starter solenoid/relay
- fuel filter

These parts are the ones that need replacing the most and can generally be replaced by anyone on the side of the road with the basic mechanics tools listed above. Some people, especially in the 4x4 community, will choose to carry drive shafts and axles as well but these take longer to replace and require more skill. The optional spare parts listed here can generally be replaced in under an hour. You would be well advised to have a long length of steel pipe, rebar or a very strong screwdriver for leveraging and tightening your alternator.

See [Basic Survival Tools](#) for additional items that should also be kept in or on your BOV. Ideally your BOV should have most of the same items as your BOB (Bug Out Bag) in it at all times, so you are never without those items.

If your BOV is dedicated to being a BOV and is not your daily driver you can keep your BOB and other gear that is not affected by temperature loaded in your BOV and ready to go with a moments notice.

# Sanitation

Sanitation in an emergency or survival situation is very important. Without water we will not be able to wash our hands or food, etc. Without running water flushing our toilets will become impossible. This means we need to think ahead to how we will cope with these aspects of emergency or survival situations. If we don't practice good sanitation we run the risk of sickness and disease.

Storing enough water for a week or more of these everyday tasks requires a lot of water. We need to have solutions to the problem of sanitation in an emergency preparedness or survival situation that requires the least amount of water possible.

## Portable Bathroom

Fortunately there are some inexpensive solutions to this problem. We'll start with a portable bathroom. Most camping/hunting stores carry a bucket toilet, such as the one below, for about \$15.

If you get one of these bucket toilets and a spare 5 gallon bucket for the seat to go on then you will always have one in use, even when emptying the bucket. You also want to get a roll of heavy duty garbage bags to line the bucket. You will need a few other things as well. You'll need to get a total of three more buckets, one should be square instead of round. You will also need sawdust, baking soda, something to scoop the sawdust and baking soda, a water tap (outside type - see picture below), a couple of washers or some pipe sealant, and a basin tub.



Fill the first bucket with sawdust and fill the second with baking soda. You should have at least one scoop of some sort to use with the sawdust and baking soda. Sealed buckets would be best for these two, this will keep the sawdust and baking soda dry.

Take the third bucket, the square one, and cut a small hole, centered and about two inches above the bottom of the bucket, just large enough to fit the water tap into. Put washers or pipe sealant on the inside and outside of the bucket to seal the pipe in place. When you are done you should have something that looks like the picture below:

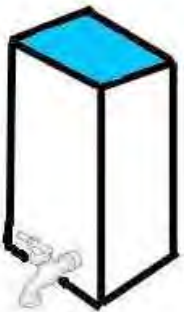

This is your water source for use when washing your hands. You can place this on the counter above your sink if you are at home, or on some sort of platform or table with a basin underneath if you are at a campsite. If the bucket has a handle you can always hang it from a tree to get it at the right level. If you keep the water filled it will be at room or air temperature. Water for washing should be as pure as possible. You should use water that you have stored yourself or use water that you have purified and know is safe.

To use your portable bathroom you first put a garbage bag liner in the bucket toilet. The next step is to put a layer of sawdust on the bottom of the bucket toilet, then sprinkle some baking soda into the bucket toilet. After you have used the bucket toilet you sprinkle another layer of sawdust and baking soda. The sawdust helps absorb any wet waste and eliminate any smell, the baking soda is to help eliminate any remaining smell.

Once you have finished with the toilet you can then move to your wash basin and water bucket to wash your hands. Your water bucket and wash basin can be used to take sponge or field baths. If hung from a high enough point you can attach some sort of hose for taking showers or washing your hair.

When not in use the water bucket can be used to store toilet paper, soap, etc so that your entire portable bathroom is ready to grab and go with a minutes notice.

Total cost, including the toilet bucket at about \$15, should be about \$35.

### **Portable kitchen sink**

This should follow the standard Scouting practice of three basins. One basin is filled with wash water, one with rinse water and one with a water/bleach solution to make sure that the dishes are clean and there is no chance of bacteria on the dishes. You can use your water bucket, or another, for use with the rinse stage of the cleaning process.

I use three Rubbermade totes with lids for this. I stack them inside of each other, the top one has a lid and inside it are my dish washing items such as soap, scrubbies, sponges, bottle of regular chlorine bleach, etc. I also use them for hand washing clothes with Woolite and laundry bar soap, and keep a bottle of Woolite, laundry bar soap, clothes pegs and rope for a clothes line. You may want to include a dish rack for drying your dishes.

### **List of items needed**

- toilet bucket, complete with seat
- spare toilet bucket, without seat
- two covered buckets (sawdust & baking soda)
- scoop for sawdust and baking soda
- square bucket (water bucket)
- water tap, washers/pipe sealant
- 3 or 4 basins
- liquid soap, gallon
- liquid soap, pump bottle
- Woolite
- bar laundry soap
- regular chlorine bleach
- dish soap
- waterless hand cleaner, antibacterial
- dish scrubbies, etc
- towels, paper and/or cloth
- clothes line and clothes pegs
- toilet paper
- sawdust
- baking powder
- garbage bags
- tarp for enclosing "bathroom" for privacy when in the woods (optional)
- dish rack (optional)

# Survival Shelter

Shelter when you are stranded in the woods, on your way to your destination, or just as a temporary shelter for a few days, is one of the most important aspects to survival. Without shelter you are exposed to the elements and your chances of survival are lowered. Most people carry a tent with them as part of their camping or bug out gear. Some people choose to use a military poncho or a tarp, or both as their shelter to cut down on the weight they have to carry. Military ponchos are great for making shelters with, they are tough, have grommets to stake or tie the corners, can be snapped together, etc.

Add a tarp along with the poncho and you can have a slightly larger shelter or add a floor to the shelter you make with the poncho. If you have two tarps you can make a larger shelter and have a floor. Two 6 foot by 6 foot or 8 foot by 6 foot tarps and some rope or parachute cord will allow you to make some nice shelters. Some people also carry a small, light weight tent pole or two so that they don't have to use sticks to support their shelter.

I suggest having two tarps for shelter and a poncho for rain gear. The poncho can be used as a door in a shelter built with two tarps, or to cover you like a blanket to help keep rain off should your shelter leak and to keep you warm. I prefer parachute cord, also called 550 or seven strand, because it is light weight yet strong. Inside the outer nylon shell are seven strands, hence the seven strand designation. Parachute cord makes an excellent survival rope since it is light weight yet strong and has many uses. The outer shell can be used as laces, to tie things while the seven strands can be used as thread for sewing or fishing line, etc. The combined breaking point of parachute cord is 550 pounds, hence the 550 designation. There are cheaper imitations out there, but always go with the real thing if you are planning on using it instead of a 1/4 or 1/2 inch rope.

Along with the two tarps and rope or parachute cord you may want to consider some lighter weight twine, two to four tent pegs and a few (4 to 6) 2 or 3 inch nails. The tent pegs can be used to stake down the corners of your tarps while the nails can be used if you are building a shelter that you plan to stay in for more than a week. Even with two light weight tent poles the weight will be less than all but the lightest tents available.

Below are pictures of a number of expedient survival shelters.

## Tarp or Poncho Wrap

Short of hunching down within your poncho this is probably the easiest shelter to construct. You wrap yourself in your tarp or poncho, like a sleeping bag, and use a stick to keep the top up. If using a poncho you want to make sure that the hood is tied so that it minimizes water getting in. You want to make sure that the bottom and foot are wrapped up so that water rolls off and you do not get wet. You can also pull pine boughs over yourself to help keep warm.

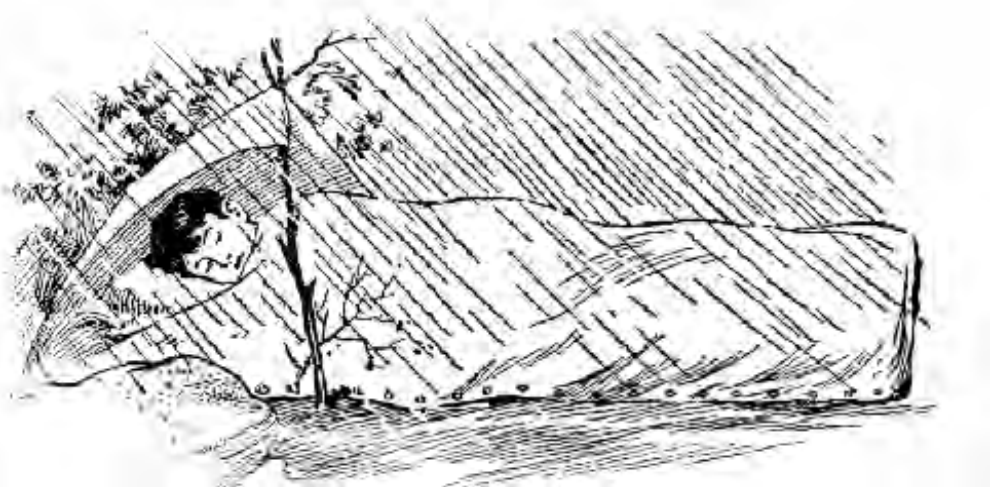

## Tarp or Poncho Shelter

A tarp shelter can be built with a tree, a stick or a piece of rope, twine and a tarp. In the top picture you see that a tree and a stick is used to hold up the tarp. You could use a piece of rope instead of the stick. The bottom picture uses three sticks; you could use the two sticks forming the opening and two pieces of rope, one to hold up the tarp and another to act as a guy rope for the two sticks forming the opening. You can use sticks or tent pegs to stake down the corners of the shelter. A second tarp, or a poncho, can be used as a floor or a "door" over the open end. If there are pine trees around you can lay them along the sides to improve heat retention and as insulation from the cold, wind or rain.

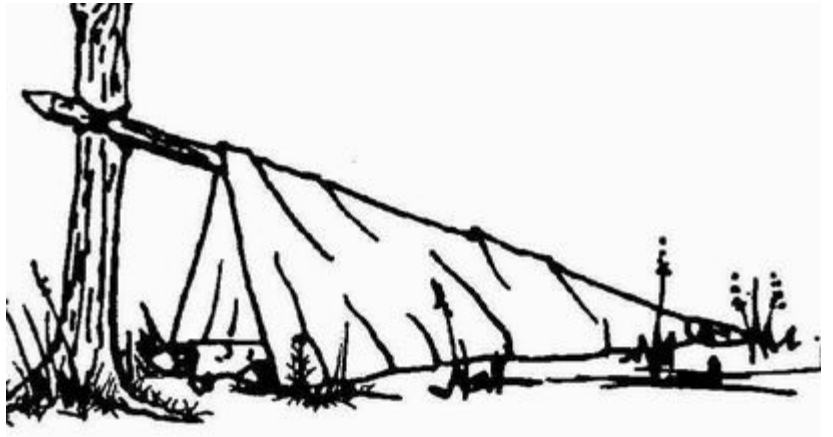

## Tarp or Poncho Tents

Below are two basic tarp tents. The top picture uses a rope from the top of the tent to a tree branch to keep tension on the roof. The bottom picture uses two sticks to achieve the same purpose. Again, a second tarp or poncho can be used for a floor or doors. And you can always use pine boughs to increase insulation on the sides.

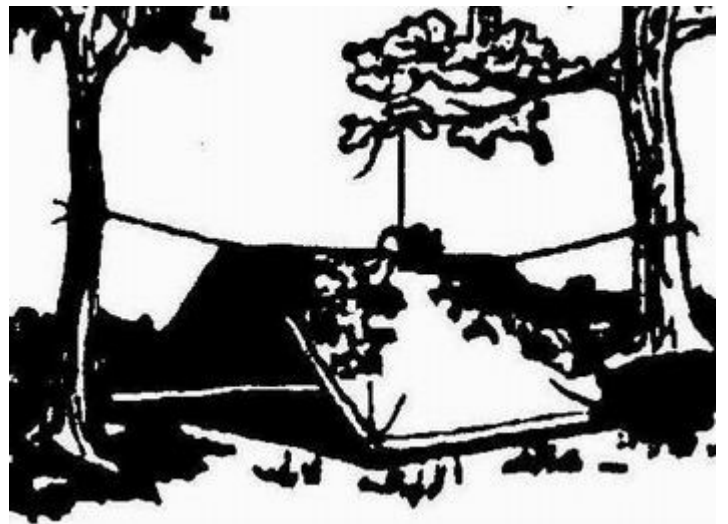

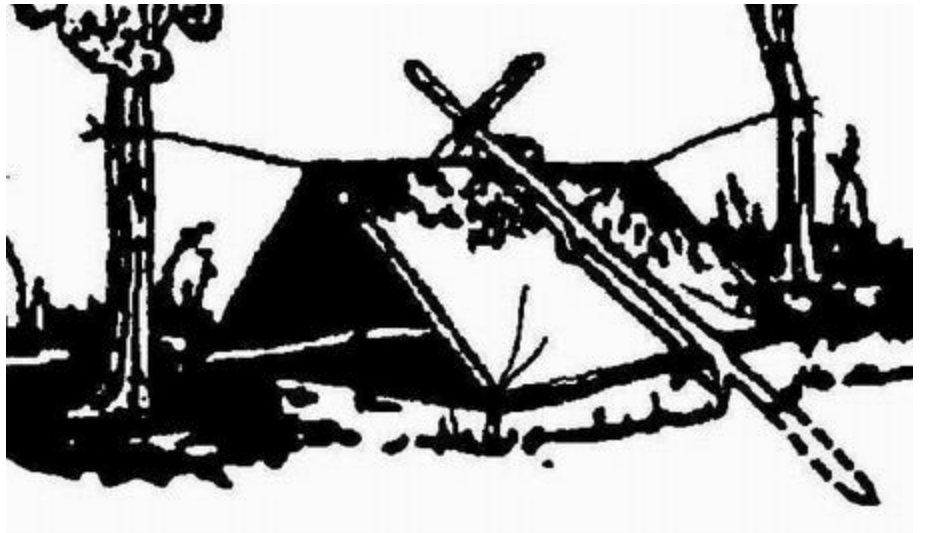

### Tarp or Poncho Leanto

This is a simple leanto built with rope tied to two trees with the tarp attached to the rope. When building a leanto you want to make sure that the tarp is on the side the wind is blowing from.

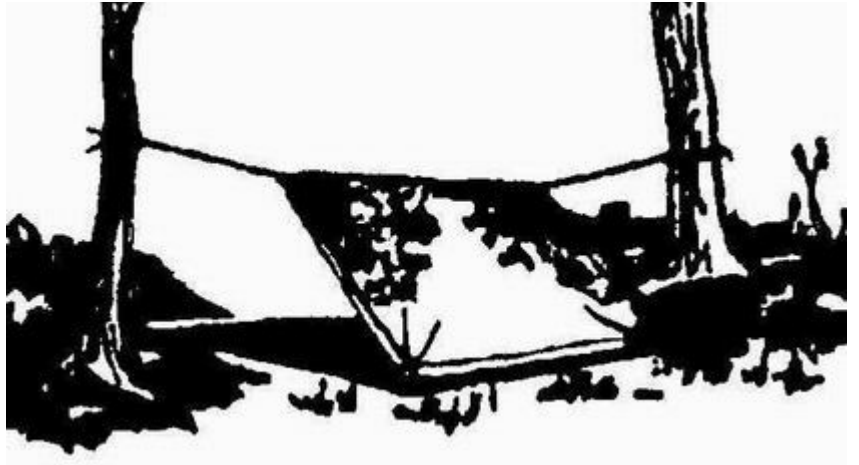

### Leantos

Below are four pictures of leantos. You will notice in the top picture that man is packing a "bough bed" full of pine boughs. There is a tarp or blanket on top of the pine boughs. Two of the pictures show a leanto built with two trees while the other two use a tree and sticks. Two of the pictures also show the use of a "fire reflector" to reflect heat into the leanto from a fire built in front of the opening of the leanto. A fire reflector will keep a leanto very warm. You can use a tarp under the pine boughs on the "roof" to keep water out of the leanto. Leantos can be made with or without sides and with or without a floor. Further down the page you will find information on "bough beds" and "fire reflectors".





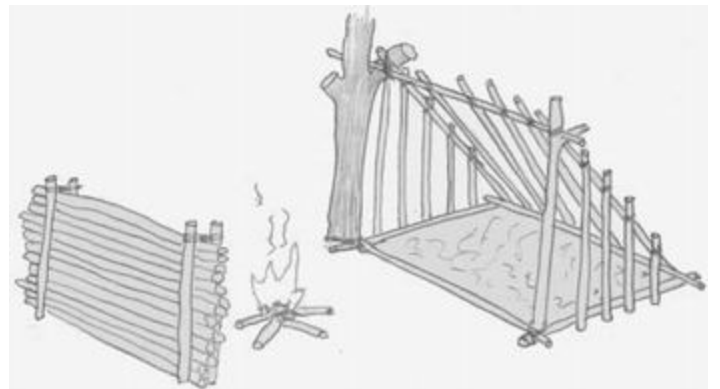
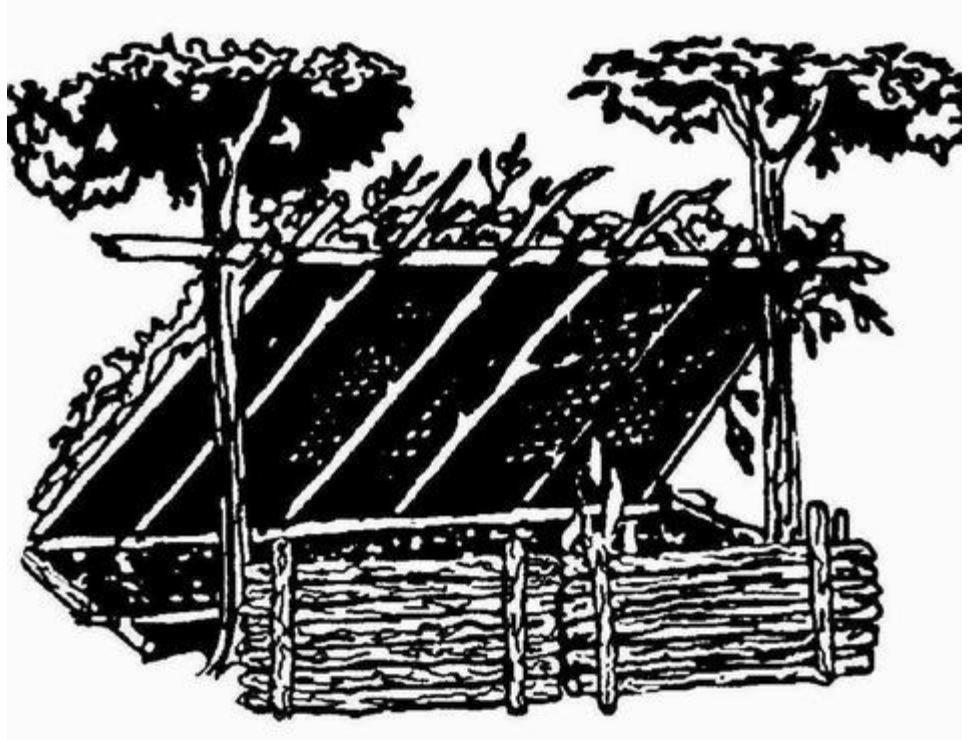

## Fallen Tree Shelter

A fallen tree can be used to form the basis of a shelter. By "hollowing" out the underside of the fallen tree you create an area to crawl into. You can improve the shelter by putting a tarp over the fallen tree and using the branches from "hollowing" out the shelter on top of the tarp. If the tree is a member of the evergreen family you can use the branches from "hollowing" out the shelter as a "bough bed". Depending on the fallen tree you may want to shore up the fallen portion with rope or branches.



A variation of the fallen tree shelter can be built under the bottom branches of large evergreen trees, you simply crawl under the lower branches and use a tarp above you to help keep you dry. This variation requires a large evergreen tree and is good for when you want a shelter that is difficult to find.

## Debris Hut

A debris hut is like a fallen tree shelter except that you are using whatever can be found to make the shelter. You can see the two stages of the debris hut below. You can of course use a tarp for a roof before you throw on the branches and whatever else you can find on the roof as insulation.

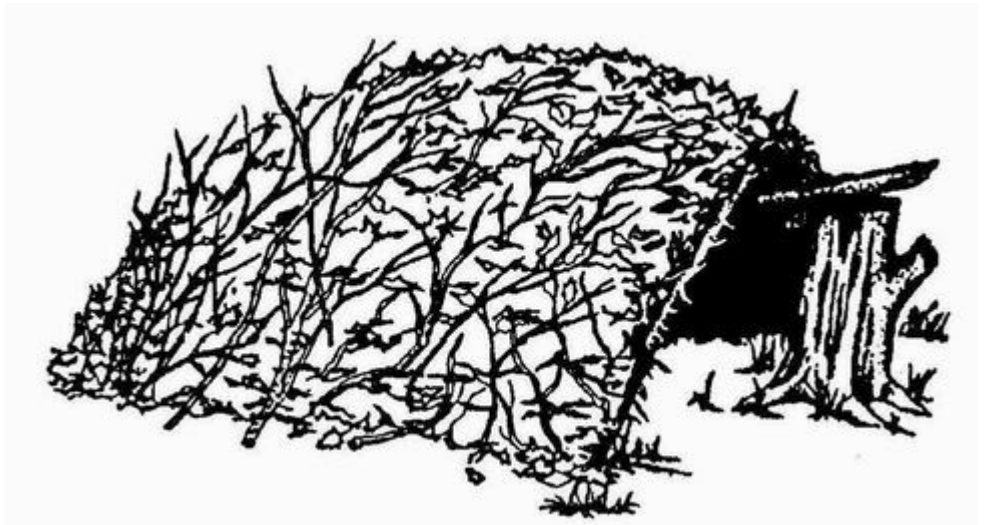
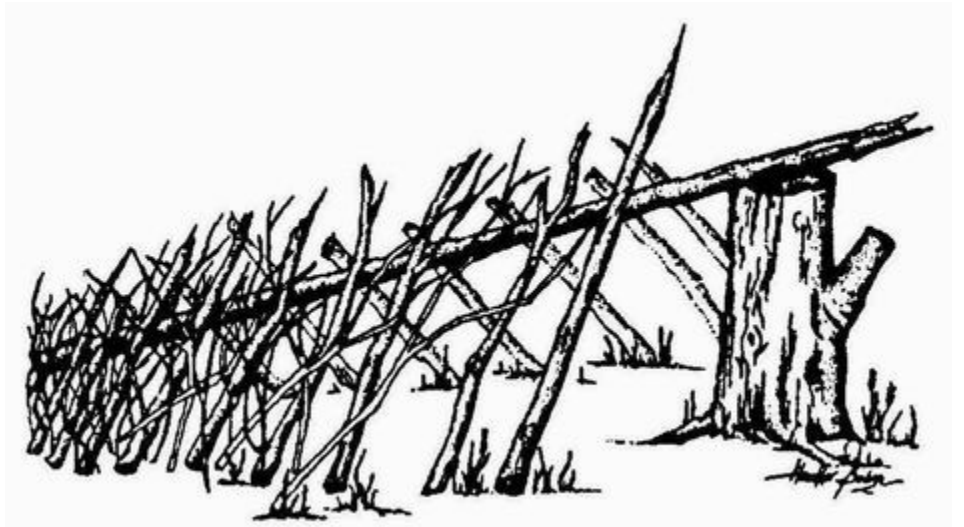

## Bough Bed

A bough bed is built using the smaller branches of evergreen trees. You lay the boughs as the floor of your shelter, place a tarp or blanket on top and it makes a nice soft bed to lie on. Tarps are preferred to blankets to cover the boughs as it also

aids in keeping you dry. In the picture below you can see that four branches or logs are used to form the outside of the bed, these are not required but will keep the boughs in place better than if not used. A properly constructed bough bed will provide softness, insulation and will keep you above the level of any rain that is running along the ground. The sides of the bed can be tied into a leanto as seen in the top three leanto pictures above.



## Platform or Swamp Bed

A platform or swamp bed can be used when in a swamp. By changing the height of the legs it can be used to keep you off the ground in a forest, sunk into the snow to create a platform for you to sleep on, etc. You can place boughs, or large leaves if in a tropical/swamp setting, on the top to form a mattress. In a woods setting a platform bed can be used to make sure that you stay dry in heavy rains, such as the Pacific Northwest, with a tarp or other shelter above you to keep falling rain off of you. The legs of a platform bed can be two logs placed parallel to each other with the cross branches laid across them.

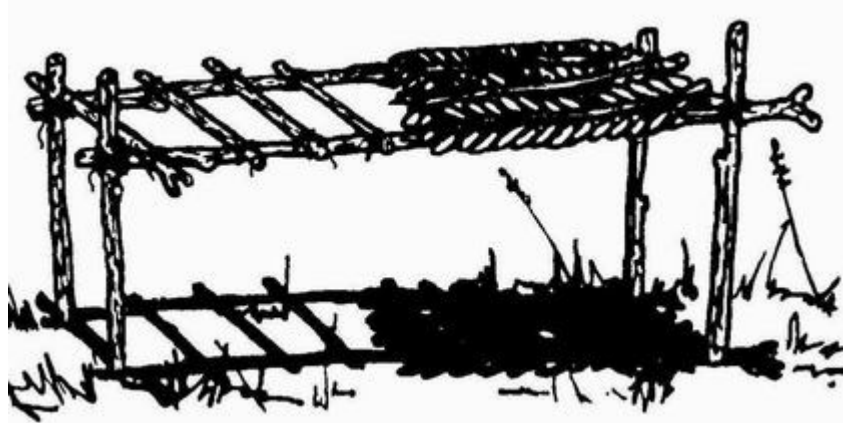

## Fire Reflector

A fire reflector is used to reflect the heat of a fire into a leanto or other shelter. Along with the back wall you can use angled side walls to get direct the heat into the open side of a shelter. The reflector should be far enough away from the shelter to ensure that you do not set your shelter on fire. The fire should also be far enough away from the back and sides of wooden walls to make sure that they are not set on fire. A fire reflector can be made from stacked logs, a large log, a rock or piled dirt.

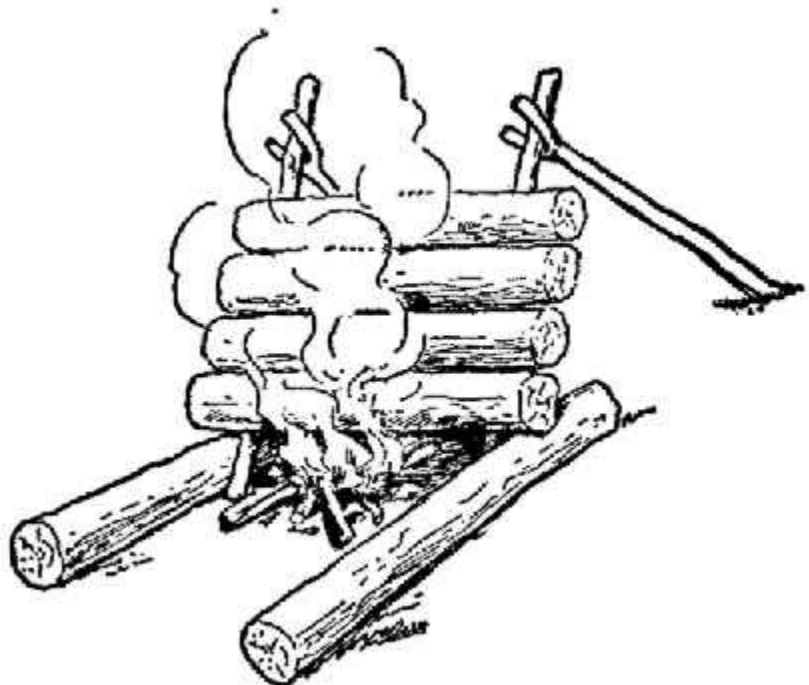

## Snow Trench

To make a snow trench you need good packed snow of at least 6 to 12 inches. You will need the trench to be a foot two longer than your height and about 3 to 3.5 feet wide. Cut the blocks from the trench area, blocks should be a foot to two feet wide and the width of the trench long and at least 6 inches thick. Basically, you will need to cut blocks from a trench twice as long as you need. Take care when cutting the blocks, laying each aside as you cut them. Once all the blocks are cut carefully lean two blocks together to form a peak in the center. Once you have made your roof you can pile snow at one end to close it off. You can also use some snow to fill in any gaps between blocks. Make sure you have a tarp, poncho or some boughs on the floor of your trench to keep you dry.

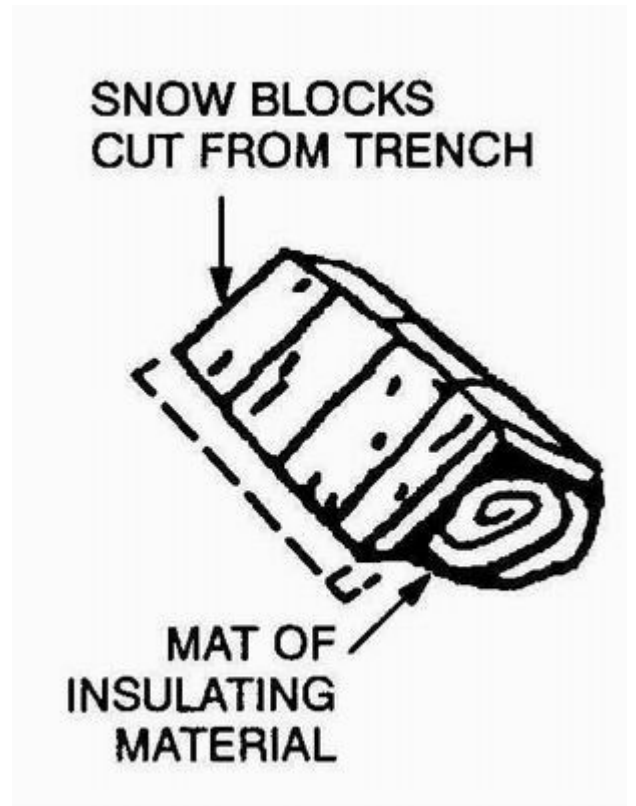

## Snow Pit

Snow pits can be built in areas where the snow is deep enough. In picture below the pit is dug around a tree with the tree acting as part of the roof. The snow has to be well packed. You could also pile snow up, packing it as you go, then dig out the center. If you pile the snow yourself make sure to let the snow sit for at least 2 to 3 hours before digging. The picture shows evergreen boughs used as a roof, you can also use a tarp or poncho.

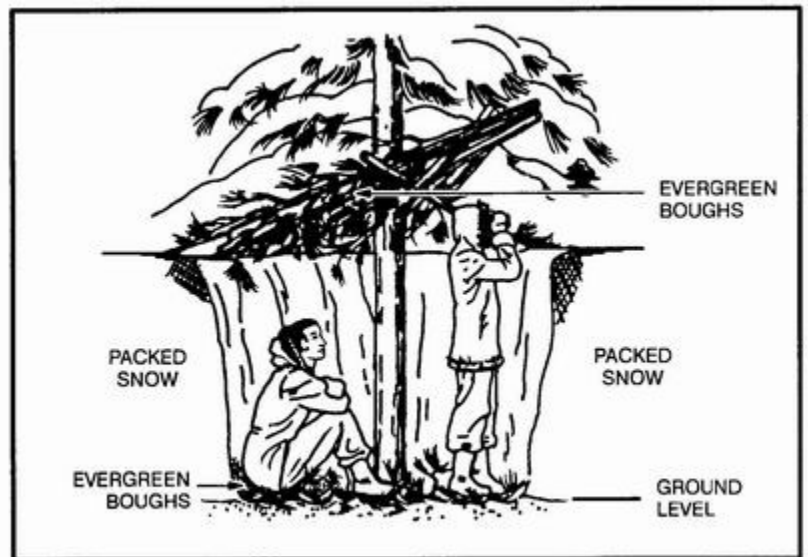
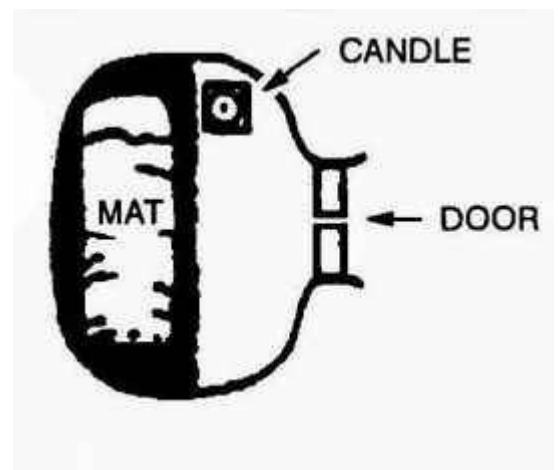
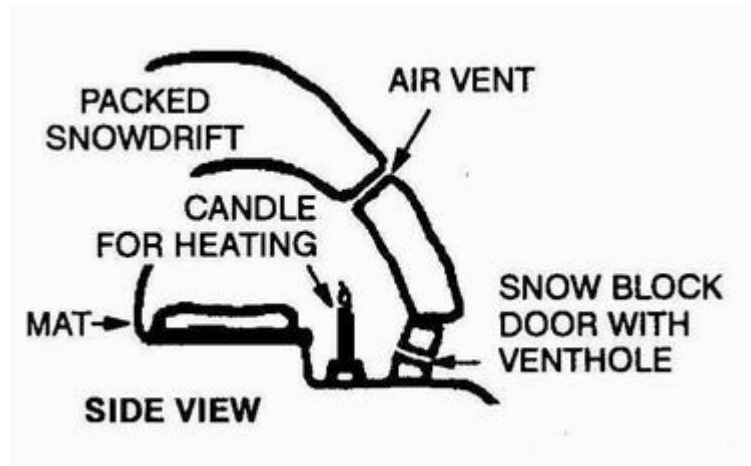

Figure 5-12. Tree-pit snow shelter.

## Snow Cave

A snow cave can be built by digging into a snow drift on the side of a hill, or that has formed around some trees. You can also pile snow up then dig into the side. If you pile the snow yourself make sure to let the snow sit for at least 2 to 3 hours before digging. You want to have a tarp, poncho or boughs between you and the snow you are sleeping on. A candle will keep a snow cave very warm.



## Snow House (Igloo)

A snow house or igloo is a very good shelter if built properly. They take practice to build properly. You have to make sure that each block is placed properly and is well "cemented" to those around it before laying the next block. You may want to consider a snow wall shelter like the one below instead.

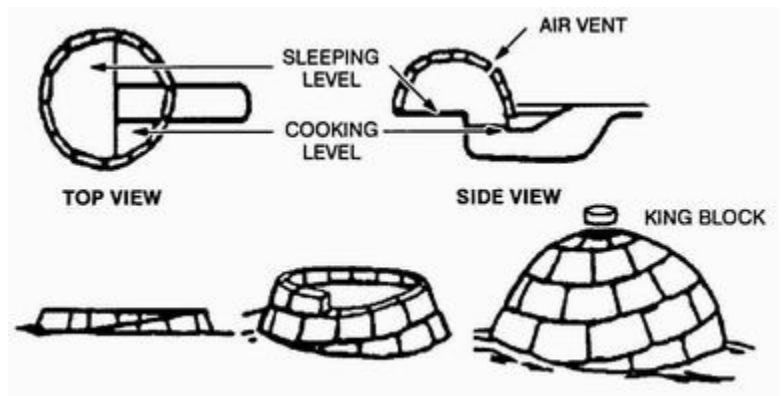

## Snow Walls

Snow walls can be built by using blocks as in an igloo, except that the walls are straight up and down. They are much easier to build than an igloo, but they are not as warm. A tarp or poncho can be used for the roof. You can also build the walls by piling and packing snow instead of using blocks. You can build snow walls large enough to provide a wind break, with room to have a fire within the walls, and then use pine boughs and snow over your sleeping area for insulation.

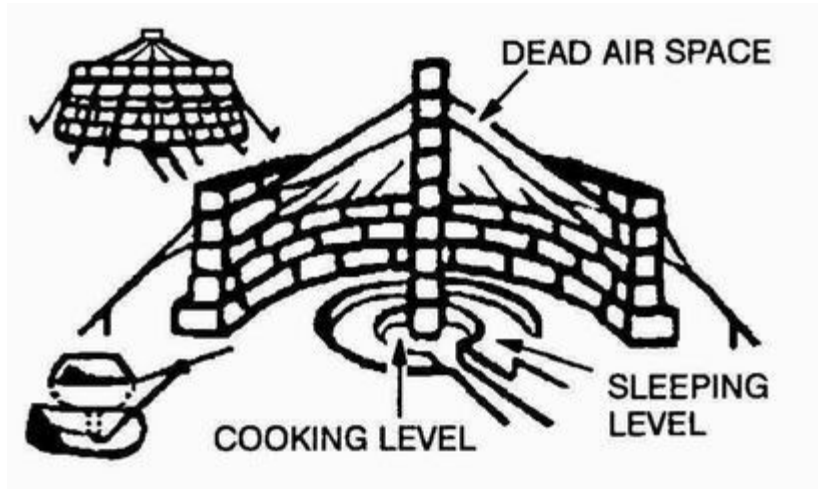

## Beach Shade

A beach shade can be built by piling sand up into walls around a shallow trench, laying a tarp or poncho across the walls and then putting some sand on top. You can also use any debris or branches to make the walls and roof for more strength.



Figure 5-13. Beach shade shelter.

## Desert - Below Ground

A below ground desert shelter is basically the same as the beach shade above, except it is deeper. The picture below does a good job of illustrating the building technique. Keep in mind that there are 30 cm in an inch. This requires two tarps for maximum insulation from the sun.

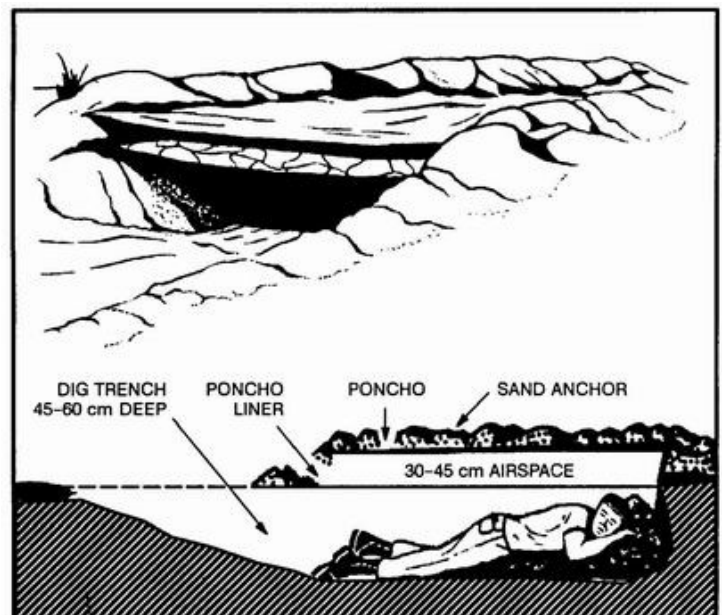

Figure 5-14. Belowground desert shelter.

## Desert - Above Ground

The same basic idea as the below ground shelter, except the above ground can be made faster. The above ground shelter is better for the day to keep the sun off of you. At night the desert can get very cold, so you would have to have some walls and insulation to keep you warm.

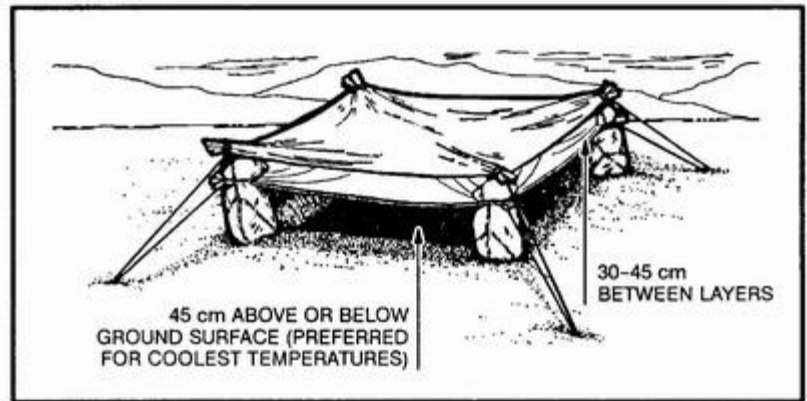

Figure 5-15. Open desert shelter.

## Conclusion

As you can see from the shelters above, there are many types of shelters that can be constructed with or without a tarp and rope. You can combine elements of different shelters to build one that is dry, warm and comfortable no matter the weather or the temperature. With a little thought and some minimal items, even just a garbage bag, there is no reason why you should go without shelter in a survival situation.

# Survival Weapon Basics

Survival weapons covers defensive and hunting weapons. These can be firearms or other weapons such as bows or crossbows. I will deal with firearms first.

Firearms can be an area of heated debate in the survival community. The question "If you could only take one survival gun, what would it be?" always comes up and results in many different answers, often with heated debate.

I'm not going to advise you on what single weapon you should have. This must be a personal decision. I will recommend a small number of firearm types that will aid you in a survival situation. I will also mention a couple of other weapon types that could help you.

First, lets get the firearms out of the way. There are many quality makers out there, check with your friends and family, the local gun store or range to get opinions on what specific models and makers to get.

## **.22LR**

The .22LR is generally considered a good survival calibre (size of the bullet). With the .22LR you can hunt small game, rabbits and squirrels, to larger game if you are lucky and a good shot. It can also be used for defense against some predators. A .22LR rifle is usually fairly inexpensive, lightweight and common. You can carry a lot of .22LR ammunition, which is also fairly inexpensive. Along with a .22LR rifle you can also buy .22LR pistols, so if you have another rifle while hunting and come across a rabbit you can use the .22LR to shoot the rabbit. Another plus to the .22LR is that any larger child and any small adult will have no problem firing it. In my opinion, every family that is considering hunting as a means to add food to the table in a survival situation should have a .22LR rifle.

## **The 30 calibres**

Within the 30 calibre range there are a number of common rounds. The .308 Winchester, the 30-30 and the .303 British are very common rounds. Any of these will make a good hunting round for larger game such as deer or bear. They are overkill for small game like rabbits. The .30 calibre rounds are also very good for self defense, all are or have been military rounds. Because the three specific calibres mentioned are common the price for ammunition is relatively inexpensive. The .308 Winchester and the 30-30 are more common in the US than the .303 British. Worldwide the .303 British is a fairly common round and is still seen in use in the military of some former British Empire and Commonwealth countries.

## **Shotguns**

There are two main shotgun rounds, the 12 gauge and the 410. The 12 gauge can be used on medium and large game with little to no overkill. The 410 is better for smaller game such as ducks and rabbits. The 12 gauge is generally considered to be the best all around self defense firearm for homes. There is something about the sound of a 12 gauge shotgun being racked/round loaded into the chamber that strikes fear into the average person... it is an ominous sound. The 410 would be better for smaller adults and larger children. Both the 12 gauge and the 410 are common, and prices for pump action versions are priced from \$100 and up.

## **.357**

The .357 makes a good self-defense and medium sized game round, it is also common and easy to find. With revolvers and carbine rifles you have the option of defensive revolvers or hunting carbines. Being able to use one size of round in two weapons for two purposes means less ammunition types you have to stock.

## **Defensive pistols**

There are any number of defensive pistols out there. The two most common rounds are the 9mm and the .45. Again there is a lot of debate as to which is better. To keep this simple, pick the one you feel most comfortable with and leave it at that. Talk with friends and family or go to the local gun shop or range. Test fire both rounds and see which one you are most comfortable with.

That covers the very basics of survival firearms. You should have enough information to start thinking about what, if any, firearms you want in your survival gear.



## **Other Weapons**

I will only briefly mention the other types of weapons here. Most people would consider these as supplemental to survival firearms and not as a primary means of hunting or defense.

There are a number of weapons that are not firearms that can be used in a survival situation for hunting and defense. The two that would come to mind for most people are bows and crossbows. Both can be used for hunting or defense. Humans have used bows and crossbows for hunting and warfare for hundreds of years. For those that can not own firearms for one reason or another, bows and crossbows are often the only option available.

Spears can be used for hunting and defense, although they require some skill to use properly. Slings and sling shots can be used for small game and with ammunition being as common as smooth stones you will never run out of ammunition. An air powered pellet or bb gun can be used for small game as well.

# Mini Urban Survival Kit

Many of us have regular day jobs and go into the city every day to get to work. For those who work in an office setting there is no way to bring a BOB. If you drive to work you can leave your BOB in the car. For those who take public transit to work a BOB is just not possible. As 9/11 showed there are a few items that every office worker should have. An emergency can happen at any time, and we should be close enough to gear to get out of the office and on your way to escaping the general area.

This sort of situation requires a small kit that we can keep with us all or most of the time. If we base our mini urban kit on the average office worker we can also apply that to any other work setting. The average office worker has a minimum amount of room to carry things with them, plus those items must fit into the general attire of the office worker.

Regardless of the specific threat, we are likely to face fire or dust, lighting being out, and debris. Since we're in a city we need a minimum of equipment, even a few blocks is enough to put most dangers far enough away that we can relax for a bit and worry about getting home from there.

Working within the attire of the office worker we need a small kit with enough items to get us out of the immediate area. If we limit the size of our mini urban kit so that it fits into part of a briefcase, laptop bag or other small bag we don't have much room. The kit itself needs to fit in these small bags yet remain easily grabbed. A small waist or fanny pack of no more than 4 inches thick by 6 inches high by 10 inches wide (about the size of a 1 gallon ziplock bag) is enough room to fit everything we need. In this kit we can keep the following:

- BIC lighter
- Nitrile and/or gardening gloves (leather palm)
- small AM/FM radio with bud earphones (shortwave/weather if there is room)
- compass/whistle/match container with matches
- small tube of anti-bacterial, waterless hand cleaner
- small pack of baby wipes
- flat pack of duct tape (3 to 10 feet)
- first aid kit (extra anti-bacterial wipes and assorted band aids)
- Emergency "space" blanket (2 if there's room)
- Money. Roll of quarters, \$10 in ones & \$20 in fives (vending machines/pay phone)
- 20 oz bottle of water (empty 1 liter platypus type bladder if there is room)
- tea/cocoa/coffee packets, sugar and creamer
- hard candy/granola or power bars
- Sunglasses, reading/spare glasses as required
- windbreaker (folds up into it's own pouch)
- bandana
- Knife or multi-tool
- keychain LED light, 2AA maglite or LED light. Extra batteries if there is room.
- military type manual can opener
- safety goggles
- 3 day supply of prescription medications
- 2 dust masks

## Small first aid kit

Most of the items above are to aid you in getting out of the building you are in, protecting your hands and eyes, making sure you do not breath in dust, and in cleaning yourself up once away from the immediate threat. In fact the first six items will fit into the first kit I suggest, while the first aid kit (with extras), the emergency blanket and the duct tape will fit into a 1 quart ziplock bag. If you were to purchase a windbreaker with zippered pockets you could fit the all of the items, minus the water bottle into the pockets of the windbreaker. You would have to grab the windbreaker and the bottled water and be on your way.



Items in a quart ziplock bag



Items in a gallon ziplock bag



The entire contents



- 1) leather work gloves with money and roll of quarters inside fingers
- 2) bandanna
- 3) whistle/match case/compass
- 4) 20 oz bottled water
- 5) LED flashlight on keychain
- 6) Gerber pouch with knife & military style can opener & folding scissors
- 7) plastic spoon
- 8) 10 feet camo duct tape
- 9) travel pack of wet wipes
- 10) emergency "space" blanket

11) radio and headphones

12) Bic lighter

13) first aid kit with waterless hand cleaner/sanitizer & pair of nitrile gloves

#### 14) 2 chocolate bars

You will notice that there is no dust mask, safety goggles or windbreaker. The windbreaker wouldn't fit on the desk tray and I normally keep the goggles and dust mask with it. The goggles and dust mask will fit into the gallon ziplock bag but the windbreaker doesn't with the water bottle.

Normally I keep the Gerber multi-tool, which has a small 3 inch Gerber Paraframe knife, Shortcut folding scissors and military style can opener, on my belt. I also keep a lighter or two in my pocket along with my keys which have the LED flashlight (\$5 Dorcy AAA from Wal-Mart).

The kit moves from waist pouch to jacket to vest, etc as need dictates. I put it in the ziplock bags to demonstrate the size of the kit. The two biggest items in the kit are the water bottle and the safety goggles, although items can be packed into the goggles.

You may want to consider adding the following if there is room:

- spoon, lexan/plastic (does not set off metal detectors)
- folding city/state map
- a small folding mesh or nylon duffel/backpack (for anything that is found)
- small tube of vaseline (help safety goggles seal to your face)
- small tube of sun screen
- water tabs
- sport bottle type water filter
- parachute cord (10 feet)
- sardine can type/size survival kit
- disposable poncho or garbage bags

The knife or multi-tool can be kept on your belt or in your pocket, as can the lighter, keychain LED and sun glasses. A bandana can be kept in your back pocket and the military style can opener on your keychain. This will free up some room in your kit for other things

If you spend all day at a desk then you can keep a few things in your desk drawer, or in your locker if in a factory, like a polar fleece pull over or light jacket, running shoes or hiking boots, spare socks, pair of jeans, t-shirt, long sleeve shirt, some extra food, bottled water and maybe a fleece throw in a small gym type duffel. Grab the duffel and survival kit and get moving until you have time to change. Many office workers keep a small gym type duffel at their desk with shoes and athletic gear for when they go to the gym during lunch or after work. Many office workers can be seen on the public transit systems with a briefcase/laptop bag and a gym duffel.

The idea behind a mini urban kit is not to keep you alive in the woods, but to get you out of buildings and to your car, on your way home, or to safety. When you think about it, most of the items on the list are fairly common items that we see many office people with. These should not attract any attention, but can make the difference between life and death or reduced injury.

If you do not have room to keep a spare pair of shoes make sure that whatever shoes you do wear have a good rubber sole and are comfortable for walking. With some looking you can find shoes that meet these requirements and remain appropriate for dress wear.

For those times when a waist pack or small duffel is inconvenient or not allowed you could get yourself a photographer's or fisherman's vest with multiple pockets. If you're getting a fishing vest and plan on wearing it in the city you may want to carefully remove the fly patch. You wouldn't come close to using all of the pockets on the vest and your items would be with you at all times.

You can see pictures of my vest with the Urban Survival Kit contents above in it.

Front View



Contents of the pockets:

- 1 - headphones
- 2 - Bic lighter & spoon
- 3 - EMPTY
- 4 - water bottle
- 5 - EMPTY
- 6 - EMPTY
- 7 - EMPTY
- 8 - 2 chocolate bars

Rear view



In the rear "Poacher's Pocket" is the windbreaker.

Inside view



Contents of the pockets:

- 1 - EMPTY
- 2 - pen
- 3 - duct tape and survival ("space") blanket
- 4 - Gerber Pouch
- 5 - travel pack of "wet ones"
- 6 - leather work gloves & bandanna
- 7 - first aid kit
- 8 - EMPTY
- 9 - radio
- 10 - waterproof match case/whistle/compass
- 11 - EMPTY

Front view with windbreaker over vest (zippered)



Front view with windbreaker over vest (unzippered)



Below are examples of other vests - a fisherman's vest and a photographer's vest, both are very similar and they usually have around 20 pockets to keep your stuff in.

Fishing Vest



Photographer's Vest



Another option for outerwear is a safari jacket. It has less pockets than a vest, but will have enough to keep your mini urban kit in. Below are a couple of examples of safari jackets from Cabela's ([www.cabela's.com](http://www.cabela's.com)).



If you want dressy with more pockets then consider a jacket from Tilley Endurables ([www.tilley.com](http://www.tilley.com)), these are more expensive but have a reputation for long life and toughness along with up to 10 pockets on the dress styles. They also have safari and women's styles as well. Below are the two men's dressy jackets.



As you can see, no matter the situation or surroundings you find yourself in there is an option that will allow you to keep your mini urban kit, or at least most of it, with you at all times. For dressy situations you will have to expend more money, but that is the price you pay for having your kit with you in the board room.



# Basic Pack

Everyone should have a basic pack, sometimes called a 72 hour kit or a "BOB - Bug Out Bag". This pack should have clothing, some food, sleeping bag, cooking gear, shelter, some basic tools, etc. This pack should be kept packed and ready to go at a moments notice. This is the bag you grab when you only have seconds to be on the road, the one that will ensure that you will be able to get to your destination, the one you can carry on your back for extended periods of time - days or weeks if needed.

Since your life will depend on the gear you have in your pack you must make sure that each and every piece of gear is well made. Because you may have to carry your pack on your back for extended periods of time you have to balance what gear you take and how much it weighs. A 50 pound pack is a lot of weight to carry for extended periods of time. Food and water will quickly add up, and winter gear can get heavy.

## Backpack

A good backpack is very important, it must fit you properly, carry all the gear you need, and be well made so that it can stand up to long term use. There are internal and external frame backpacks. External frames allow you remove the bag and use the frame for transporting cargo, plus it is much easier to attach gear to the outside of the pack. One modification is to attach a couple of straps to the frame that go around the bag, this reduces stress on the attachment points. Some options to look for in a backpack are hydration bladder compatible and removable day pack.

Below are a number of external frame backpacks from Kelty, Jansport, Cabela's and Dwight Schuh.



Below are medium and large A.L.I.C.E. packs, they are highly thought of by many ex-military guys. The packs allow additional pouches to be attached to them which makes them very customizable.



### Basic Tools

You should have some basic tools as part of your gear. A small 1 to 1.5 pound hatchet, a take-down saw, shovel and 24 inch machete have minimum weight (about 5 pounds for everything) and will allow you cut wood, clear brush, dig holes and build a long term shelter if required. Make sure your purchase products with good quality steel. The shovel should have a fixed wooden handle, to allow replacement of the handle, while the hatchet should have a wood handle to allow replacement or a quality steel handle such as the Eastwing - Eastwing is the only steel handle hatchet we recommend as most others are poor quality tube steel handles.





**Knives & Multitools**

We would suggest three items here. A 4 inch folding lock blade knife for general use, a 6-8 inch fixed blade knife and a multi-tool. For multi-tools Leatherman and Gerber are very good. We give the edge to Gerber because the tools are on the inside of the handle which means they don't dig into your hands or fingers, plus Gerber makes a model that allows you to change the plier heads (Evolution 650).



Make sure that you have a sharpening kit and know how to use it.

**Navigation**

A good compass or two should be carried. Silva makes great compasses, as does Brunton and Suunto. Your compass should have a sighting mirror and declination adjustment. You should also have maps and know how to use them and the compass. GPS units are great, but the last thing you want to do when you are trying to survive is to rely on something that needs batteries... there are no stores in the wilderness and solar rechargers can take hours to recharge a set of batteries.



## Shelter & Warmth

You can choose a tent, a tarp or two, or a poncho for your shelter. If you choose a tent make sure that you can easily set it up and that it does not weigh too much. Dome tents are very convenient and lightweight but it is difficult to use a rope and two trees to support a dome tent, for that reason we are partial to "A frame" or "pup" tents - you can always find some sticks to replace poles or use a rope strung between two trees to hold it up.

Eureka makes consumer and military tents, visit their site for more information and a wider selection tents.

A military style poncho, ripstop nylon or rubberized nylon with connector snaps on the side and liner can be used to keep the rain off of you and to provide shelter, add a pair of rain pants for total protection from the rain for you and your gear. Add a tarp or two and you have a light weight multi-use shelter.



## Eureka! Tent The StormShield



## Food & Water

Because food and water weigh so much you must make sure that the food you have is lightweight - freeze dried/dehydrated - and that you can obtain more food along the way through eating wild plants and catching animals with snares, etc. Initially you can carry three days of food, more if you have room and can carry the weight; and one gallon water (about a days supply). Instant potatoes, instant oatmeal, instant rice and bullion cubes along with basic condiments can greatly improve a meal and are easy to prepare, some light weight snacks are also good to have along.

Make sure that you have a means to purify the water. Water purification can be tablets or



filters/purifiers such as the pump and gravity ones shown below. The Katadyn Base Camp gravity bag filter can be hung on a tree, or on your pack with the hose going into a canteen for purifying while you are walking.



Bottle style filters like the Katadyn on the left are generally not as good at purifying water as pump or gravity based purifiers. Independent tests on the Berkey Sport, on the right, show that it is as good or better than many purifiers.



What ever purifying method you choose make sure that you have spare filters and maintenance kits if they are available. For very dirt (sandy, etc) water you may want to use a nylon stocking and/or some coffee filters to remove as much of the particulate as possible before the water goes into the filter.

For information on these purifiers see the manufacturer's sites: [www.katadyn.com](http://www.katadyn.com), [www.msrcorp.com](http://www.msrcorp.com) and [www.berkeywater.com](http://www.berkeywater.com).

A standard 1 quart military canteen with cup (stainless steel), stand/stove and an "ESBIT" stove that uses solid fuel is a good idea. The canteen pouch will hold the canteen, the cup and the stand/stove along with a bottle of water purifying tablets. The "ESBIT" stove fits in the cut out on the bottom of the stand/stove.



A 5 quart collapsible canteen can be used as a pillow or flotation device as well as carrying water.



### Fire

You should carry some strike anywhere wooden matches in a waterproof match case, a disposable Bic lighter or two (don't get the other brands of disposable lighters), a Zippo lighter (stick with the Zippo brand) with extra flints, a wick and 4 oz of lighter fluid (Ronsonol makes the best flints and fluid) and a magnesium fire starter. You can make a nice striker for the magnesium fire starter by taking a 6 inch mini hack saw blade and cutting it in half, you can punch out the peg, put a small key ring on it and attach it to the magnesium fire starter.



### Misc.

You may want to consider a shortwave radio to allow you to listen to what is going on. Kaito makes some very nice multiband shortwave radios that can be powered by solar, battery, AC or crank.

Copies of the US Army Survival Manual FM 21-76 (or current version US Army Survival Manual FM 3-05.70) and the Collins Gem version of the SAS Survival Guide ISBN 006084982 vacuum sealed for protection should be in your pack. You may not think you need them but with the pressure of leaving home and heading into the unknown they come in handy as

reminders, plus it does give you something to read and allows you to brush up on basic skills.

You should have a basic first aid kit and prescription medication and a personal hygiene kit in your pack.

You could also get a military style web belt and a couple of small pouches to put the canteen and pouch on and to keep key items with you at all times.

This is not a complete list of the items you could have in your pack, it is a basic list of some key items.

# Sleeping Gear

A good night's sleep is very important, and one of the few luxuries when you're on the road or busy making a base camp. Just because you're living out of a backpack, your car, or you've just arrived at your destination does not mean you have to sacrifice having a good night's rest.

Your sleep system should include a sleeping bag (or sleeping bag system of an inner and outer bag) that will keep you warm to -40 degrees F/C, a fleece sleeping bag, silk or other synthetic liner and a pad of some sort. Fleece sleeping bags can be used on their own during warmer temperatures or used inside your sleeping bag for an increase of 10 to 20 degrees Fahrenheit (5 to 11 degrees C). Silk or synthetic liners are to aid in keeping your sleeping bag clean, it is much easier to wash a silk/synthetic or fleece liner bag than it is to wash a full size sleeping bag. The sleeping pad serves two purposes, one to provide insulation from the cold ground and heat loss, and two to provide padding for a better night's rest. A small packable pillow is nice to have as well.

A "sportsmans space blanket" is very similar to the thin emergency/space blankets that sell for under \$5 with one big exception - they are much more durable. They can be used as a ground sheet, as blanket on top of your sleeping bag to help keep heat in, and several other uses.

The last item on the list is a cot. A cot is great if you have the room in your vehicle and for once you reach your destination, or any base camp along the way. Although you wouldn't want to carry a cot if you were traveling on foot it is one of the luxuries you may want to consider if you have the room and the budget.

As you can see we concentrated on mobile/camping gear. Regular household sleeping sets should also be packed. In a worst case scenario you may not have much time to pack your vehicle or may be forced to travel on foot only taking what you can carry. The main items below can be carried in a back pack. You can never have too much in the way of sheets, blankets and comforters, so bring as many as you have or can fit in your vehicle.

Below you will find recommendations for sleeping gear that will keep you warm in temperatures down to -40 degrees F/C.

## Sleeping Bags

The Cabela's Alaskan Guide model comes in mummy and rectangular designs, each with a hood. With various temperature ratings from 0F/-17C down to a single bag at -40 degrees F/C. The most expensive model is \$270.00, a far cry from the \$600-\$700 for name brand sleeping bags with a -40 degree F/C rating.

We developed the Alaskan Guide Model Sleeping Bag to give you maximum performance in the harshest conditions. Our revolutionary Dual-Insulation Technology, an exclusive combination of the highest-quality materials and insulations, is the heart of what we feel is the finest sleeping bag on the market today. We think you'll agree.

*Curt Dinges*  
Curt Dinges  
Cabela's Purchasing Specialist  
Camping/Outdoor Gear

- No. 10 YKK® zipper
- Dual insulation technology for maximum warmth
- DURASHIELD® outer shell

Mummy

Includes 100% waterproof stuff sack

Rectangular

Insulation: 650-fill-power goose down (top)  
Thermolite® Extreme (bottom)  
Shell: Durashield T3™  
Liner: 220T Cotton  
Zipper: No. 10 YKK®  
Plus: 100% waterproof compression stuff sack

Traps Body Heat  
Outer Fabric  
Inner Lining  
Thermal Bonding Fibers  
Fine Denier Fibers  
Hollow-Core Spring Fibers

Thermolite®

The Wiggy's two bag system is good to -40 degrees F/C when the inner and outer bag are combined and is constructed of a proprietary laminate. These sleeping bags are used by the US Navy SEALs. The total cost for these is over \$450.00. Wiggy's also makes a sleeping bag that is good to -60F/-51C available in single and two bag systems with a price range of \$350.00 to \$595.00. They will also compression pack your sleeping bag for an additional \$175.00 to the size of a cushion. For more information on the -60 sleeping bag see [www.wiggys.com](http://www.wiggys.com).





Fleece sleeping bags can be used in warmer weather or as a liner in another sleeping bag to increase the temperature rating. They will also help to keep your sleeping bag clean. There are several manufactures of sleeping bags and several retailers so shop around, make sure the fleece bag you buy is of good quality and the right size to fit your sleeping bag - many of the cheaper fleece bags are somewhat small.



**Sleeping Pads**

A sleeping pad can be anything from a \$5 blue closed cell foam pad to a \$200 deluxe, self-inflating pad with some foam. There are three options pictured in varying price ranges of the latter type. The self-inflating pad



with some foam provides insulation and a somewhat customizable padding level to aid in comfort. A pad of some type is

highly recommended if just for the insulation value.



### Sportsmans Space/Thermal Blanket

These range in price from \$10 to \$13 depending on the store you buy them at. These are lightweight and have many uses. They are well worth the price and weight.

As mentioned earlier, they can be used as a ground sheet to reflect heat back up and prevent loss of heat to the ground or as a blanket on top of your sleeping bag, or both. Some of the other uses include as insulation inside your tent, or with a hole cut in them as a poncho liner - in which case they can greatly increase the warmth of a poncho and poncho liner.



### Cots and accessories

A cot is great to have if you are at a base camp, but too heavy to pack on your back when traveling on foot. With accessories including pads and other items they can make any base camp a lot more comfortable. Cots are one of those luxury items that come into play when you have the room to pack them in your vehicle and the money to spend on them. Below is one of the better ones available from Cabela's.

**Huge 40" X 85" size**  
**Includes Cabela's Cot-Side nightstand**  
**400 lb weight capacity**

**Cot Tree**

**Deluxe Cot Pad**

**Cot**

**Nightstand**

**Heavy-duty innovative Frame joint system for maximum support**

**FREE Cabela's Cot Side Nightstand with Outfitter XL Cot Purchase \$29.99 Value!**

**Over 1,200 lbs.**

# Cooking Gear

Cooking gear comes in two areas, hiking and base camp. Hiking sets are lightweight and are carried in your backpack while base camp sets are heavier and entail much more in the way of quantity and varied items. We have broken cooking gear into these two areas. At the very least you should have a set of hiking cooking gear.

There are two things we recommend against - aluminum and non-stick cookware. Aluminum is not as durable as stainless steel and doesn't cost much less while non-stick coated cooking gear can be scratched which effectively ruins it. Both have also been linked to various medical conditions, so why chance possible medical problems in the future and less durability in the present?

We recommend stainless steel with copper bottoms for hiking sets and either stainless steel with copper bottoms or cast iron for base camps. Many modern stainless steel sets come with aluminum on the bottom surrounded by stainless steel - these are fine if you can't find solid stainless steel or copper bottoms. Copper pots and pans intended for cooking food are fine, keep in mind that there are many copper pots and pans that are for decorative purposes and are not for cooking food.

## Hiking

Your hiking set should be stainless steel, preferably with a copper bottom for even heat distribution. At the least your kit should have a 3 quart pot and a 1 quart pot along with the lid/fry pan for each. Here is a set from Coleman but it does not have a copper bottom. Wal-Mart has a decent "family" set for about half the price of the Coleman set pictured and it does have a copper bottom.



A percolator coffee pot is great for making coffee and heating water. Below are some examples of coffee pots of this type available from Cabela's, we suggest the 14 cup at minimum due to the handle that will allow it to be hung over a fire. Again stainless steel is preferred to aluminum. Sportsman's Warehouse and Gander Mountain also sell these types of coffee pots although their websites do not list much aside from store location and current fliers.



You should have a stove for those times when you can't have an open flame for whatever reason. The stove should be small, light, and burn multiple fuel types. The Coleman (left) will run on Coleman fuel (whitegas)/unleaded gasoline/kerosene while the Brunton (center) and MSR (right) will run on even more fuel types. If a repair or maintenance kit is available you should pickup at least one or two and store them with the stove. You should shop around for fuel bottles to keep spare fuel in and to allow quick change over if needed.

Along with the items above you should have one or two mugs per person to allow for hot and cold drinks. Insulated stainless steel mugs are perfect for this. You may want to consider a thermos or two to keep drinks or food hot (or cold) for when you are on the move. A slim pint (500 ml) thermos is great for coffee or liquids while a widemouth quart/litre thermos is also good for food. You can find good quality thermoses for \$10 to \$20 each, stay away from "pour through lid" type thermoses as these tend to leak.



Don't forget to bring along cutlery (including a steak knife) and basic utensils, dish soap, etc.

### Base Camp

Base camp gear includes all the same things that you would normally have at home - pots, pans, cutlery, utensils, measuring cups, etc. We suggest that you stick with stainless steel measuring cups and utensils for durability. It also includes the means to do the actual cooking such as grills, fire rings, barbeques, stoves, etc. We suggest cast iron, stainless steel with copper bottom or all copper for pots, pans and other cookware. Pre-seasoned cast iron is available from many retailers.



Cast iron will last for generations and when properly seasoned will become non-stick after some use. Cast iron can be found at second hand and thrift stores as well as from retailers and manufacturers. Studies have also shown that women who use cast iron are less prone to being anemic or suffering from low iron.

Please note that none of these are requirements. Aside from pots, pans, etc the items shown below are to give you an idea of the many different options available.

Lodge - [www.lodge.com](http://www.lodge.com) - Manufacturer of quality cast iron cookware. Sportsman's Warehouse - [www.sportsmanswarehouse.com](http://www.sportsmanswarehouse.com) and Gander Mountain - [www.gandermountain.com](http://www.gandermountain.com) both sell cast iron (and other base camp gear) although their websites do not have much other than store locations and current fliers.



The cooking system on the right has everything you need for cooking over open flame. A bus rim and a grate of some sort can make a great fire pit as well.



Below are three different types of grills for smaller fires.



A tripod comes in very handy when you have a dutch oven that can be hung from it's handle. It will allow for adjusting the heat by using the chain to adjust the height of the dutch oven.

This Dutch Oven table is a unique item. Designed for cooking with cast iron dutch ovens it uses charcoal like a barbeque but does not have a grill.



The Coleman 3 burner dual fuel stove uses Coleman fuel (whitegas) and unleaded gasoline, both of which are readily available.

Add one of these propane converters to the stove and you can use 1 pound propane bottles with your liquid fuel stove. These are available from Wal-Mart for about \$15 and are as easy to install as the fuel tank on the stove to the right.



Add a distribution tree and adapter hose and you can use up to three propane stoves or other items that work on 1 pound propane bottles.



Camp kitchens like these provide cooking space and convenience.



Water purifiers like the Berkey series (top), the Katadyn Expedition (bottom left) or Katadyn Base Camp (bottom right) ensure that the water you use to cook with and drink are safe.



A turkey cooker pot can be used for many things including boiling vegetables, etc.



Heavy duty propane stoves/burners for serious cooking.

A charcoal smoker to smoke your own meat.



Here is a neat stove/oven combo that runs on propane from a standard bulk tank or 1 pound bottles if you buy the adapter. For \$200 you can be baking cakes in the great outdoors as well as cooking on the burners.





# Winter Clothing

Because the area around you may get cold during the winter you must have good winter clothing and gear. Having clothing and gear that will not stand up to the weather conditions could cause you to die.

It may sound cliché, but layering is the best approach to winter outerwear. Layering should consist of at least three layers: a base layer - thermal underwear of silk or synthetic cloth, a mid layer such as a long sleeve shirt or sweater and an outer layer. Many people with extreme cold experience will wear a base layer, a long sleeve shirt, a sweater, a lighter weight jacket and then their parka. Some wear a down vest for core warmth which also provides additional warmth in extreme cold when they will not be active. A down vest and mid-weight jacket can provide warmth in most cases when combined with other layers.

By using layers of clothing you can more effectively control your temperature, being too hot can be as dangerous as being too cold as you will be tempted to remove a heavy layer of clothing. You can unzip or remove one or more layers if you get hot, you can also zip or put on another layer if you are cold. Air trapped between layers adds to the insulation value of your clothing. Below is an explanation of the layer system.

- Base layer (underwear/thermal underwear/T-shirts)
- Layer 1 (Shirt/Pants)
- Layer 2 (Sweaters)
- Layer 3 (Light/midweight jackets)
- Layer 3.5 (Down vests)
- Layer 4 (Regular winter jackets)
- Layer 5 (Parkas/snow pants/snow suits)

There are several levels of cold: cool, cold, very cold and extreme cold. You should have a layer for each level of cold, the first four (and base) layers when combined should provide you with clothing for extreme cold. We have said that your base layer should consist of silk or synthetic because cotton becomes dangerous to you when wet. Down, wool, silk, polar fleece and other synthetics are the preferred cloth for cold weather gear, cotton blends are better than 100% cotton but still a long way from the others.

Below you will find items for each layer, starting with Layer 5.

Please remember that winter is unforgiving, you must balance cost with performance. When it comes to winter gear low cost usually means poor quality and/or short life. Cabela's has a 100% satisfaction guarantee, few companies offer this level of guarantee, this means that they stand behind the products they sell as well as their name brand.

## **Parka (Layer 5)**

A good down parka is hard to beat. There are many parkas out there, by many manufacturers, as well as surplus military gear. We prefer down for the simple reason that centuries of use has proven it to be a good insulator and lost down feathers can be replaced. A good parka should have slash hand warmer pockets on the chest, at least two bellows outer pockets for gloves and other gear, and one pocket inside for other items. Fur on the hood is optional, but highly suggested as it keeps snow from sliding into the hood opening. The hood should be of the tunnel type, adjustable to properly size it, with a wire in the edge of the hood to allow for making the opening smaller. The parka should be long enough to cover to the top of your knees, have a waist drawstring, and have a two-way zipper that allows you to unzip from the bottom as well as the top, and a button or snap storm flap. Buying a size bigger than you normally wear is fine and will allow for layering in extreme cold.

One of the best, and very reasonably priced, comes from Cabela's. There are better parkas out there, but with prices that go to above \$500, the Cabela's parka is a good blend of price and performance. Below is a picture of the Cabela's parka we recommend. Available in regular length sizes from small to 5XL and tall length in sizes medium to 3XL there is a size to fit almost everyone, prices range from \$180 to \$220 USD. The range of sizes, reasonable price, and quality is why we recommend this parka over others.

Other brands/retailers:

Canada Goose - [www.canada-goose.com](http://www.canada-goose.com) - Some of the best down parkas available, priced to match.

Woods Canada - [www.soodscanada.com](http://www.soodscanada.com) - No online store.

Wiggy's - [www.wiggys.com](http://www.wiggys.com) - Laminate based, expensive but very good.

S.I.R Mailorder (Canada) - [www.sirmailorder.ca](http://www.sirmailorder.ca) - Sells Woods and Canada Goose products.



### Snow suits (Layer 5)



## Snow Pants (Layers 4 to 5)



## Headwear (Layers 3 to 5)

With a large portion of heat lost through your head it is very important to have proper headwear. Below are several styles of headwear that will keep you warm in any situation.

The classic watchmen's cap or toque, available in wool, wool blends and synthetics such as polar fleece.



Below is a polar fleece hat that can be worn four ways to provide the protection from the cold you need.



Below is a classic style northern fur hat with ear flaps.



For extreme cold or high activity levels the two face masks and the head covers below are great. Using the heat of your breath to warm the air coming in it prevents your lungs from freezing. Available in two styles, face mask and head cover/balaclava, and two technologies, these will help keep you warm in the coldest of weather and highest activity levels. The face mask can be worn in combination with a toque/watchmen's cap, balaclava or other head covering to provide total head protection from extreme cold.

Available with or without  
**SCENTLOK**  
ODOR ELIMINATING TECHNOLOGY



- Reduces stiffness and numbness
- Eliminates up to 40% of heat loss
- No condensation or freeze up
- Headcover now offered with Scent-Lok lining



To round out your headwear you should have a good pair of non-fogging, polarized snow or ski goggles. Snow blindness is a very real threat and polarized goggles will help prevent the glare reflected from snow and ice from causing snow blindness. Also, goggles will protect your eyes from blowing snow and prevent your eyes from drying out due to wind.



- Small module in facemask warms the air you breathe and allows you to enjoy winter recreation at its best
- Compact, lightweight and cleans easily
- Stays dry - Moisture does not condense on the fleece
- Tested at -40 F and does not frost

### Hands (Layers 3 to 5)

Cold hands in the winter are no fun and can lead to frostbite and the loss of fingers or entire hands. Although there are good gloves out there, a good pair of mittens is far better due to all of the fingers being surrounded with one piece of fabric and insulation. You should have a good pair of wool or fleece gloves or half gloves for when it is not too cold and when you need the added dexterity of gloves, a good pair of wool or fleece mittens for intermediate cold - you can pick a size so that you can wear your gloves or half gloves as a liner. A compromise on half gloves and mittens is the "glomitt" which is a half glove with a fold away mitten pouch.



For extremely cold weather mittens such as these are the best solution, with a gauntlet

style they will cover the sleeves of your parka, the fur on the back of the hand can be used to wipe snow from your face while the velcro and drawstrings can be used to seal them well to prevent snow from getting in. You may want to get a durable pair of leather gloves or mittens for times when you will be doing hard work such as chopping firewood. You may want to consider a lanyard to attach to the mittens so that you do not have to worry about losing them.

### Feet (Layers 3 to 5)

Reflective light-weight waterproof shell

8" liner allows for pants inside boots

"One pull" roller bearing hardware

Rubber toe cap for extra wear

Heat pack pocket for toe warmer heat pacs

13MM EVA cold barrier footbed

Moisture trapping footbed

Ripstop snow guard cuff

Moisture wicking lining

Waterproof membrane

Radiantex™ reflective coating

Abrasion resistant heel & toe guard

13MM Texel® liner w/moisture control

**SAVE \$5 Off MSRP**

Sugg. Retail \$104.95

**-40**

**100% WATER PROOF**

**-135**

Your feet are very important and are often the coldest part of your body in extreme cold. Like your hands, improper footwear can lead to frostbite and the loss of toes or entire feet. It is of extreme importance to have proper footwear. You should wear liner socks of silk or synthetic that will wick away moisture and then a wool sock for warmth. ALWAYS keep at least one pair of dry socks with you if you are traveling anywhere - clean, dry socks can make a big difference in morale and in the health of your feet.

We suggest two pairs of winter boots, one for temperatures down to around -40 and one for extreme cold. When it comes to boots DO NOT consider cheaply made boots - ALWAYS buy the best boots you can get. Below are good winter boots by Sorel that are good to -40 and then "pacboots" that have ratings from -130 to -150. Remember, when your feet are cold the rest of you will feel cold as well.

For general duty boots, including cool to cold temperatures Danner boots are very good. Soldiers around the world swear by their "Ft. Lewis" boots and consider anything with the Danner name on it to be the best in the world. Danner boots are available in insulated and uninsulated versions. In general we suggest that people stay away from steel toe boots - the steel cap will attract the cold and can cut off your toes in certain situations.

For a larger selection of Danner field boots [www.danner.com](http://www.danner.com).

**Danner**

**Cabela's EXCLUSIVE**

**Ft. Lewis available in ANSI certified safety toe. Insulated with 600-gram Thinsulate Ultra.**

**GORE-TEX**

**WATER PROOF DURABLE & BREATHABLE**

**Acadia**

**Commander**

**Thinsulate Ultra INSULATION or Uninsulated**

**Vibram**

### Jacket (Layer 4)

Sometimes called 3 Season or 4 Season jackets these should be good for most winter weather, and good to at least -40 with other layers (3, 2 & 1) worn underneath. Usually these consist of an outer shell that is wind and water proof, which can be worn alone for the wind and water proof properties, and then a liner that can be worn on it's own as well. The jackets can have down or Thinsulate for insulation. In the case of wool jackets the wool provides the water proofing and insulation in a single layer. In either case this is your basic "winter jacket".



### Down Vests (Layer 3.5)

Down vests can be worn in conjunction with other layers to increase warmth. Worn over a long sleeve shirt or sweater they can greatly improve your comfort. Vests are at their best when you are temperatures between the point of a Light or Midweight jacket and a "winter jacket". Season wise, this would apply to mid-spring and mid-fall.



### Midweight Fleece & Wool Jacket (Layer 3)

Light or Midweight jackets should keep you warm to temperatures around 0C/32F. A down vest can be worn for those times when it is too cool for a Light or Midweight jacket and too warm for a "winter jacket". Season wise this would apply to early-spring and late-fall.



### Sweater (Layer 2)

Sweaters can be fleece, wool or some other insulating synthetic. In temperatures below 10C/50F or so you should have a sweater with you.



### Wool & Fleece Shirts (Layer 1)

A long sleeve wool or fleece shirt should be worn from fall until spring. You can roll up the sleeves and wear a T-shirt underneath with the shirt open, but the extra warmth is well worth the light weight of a long sleeve wool or fleece shirt.



### Wool & Fleece Pants And Bibs (Layer 1)

Because wool and fleece will keep you warm when wet they are much preferred to cotton based pants. Regular sythetic pants like polyester and other lightweight synthetics do not have the drawbacks of cotton but they also do not have the insulating benefits of fleece and wool. A good heavy wool or fleece material will keep you warm and dry and will outlast lightweight synthetics.





**Thermal Underwear (Base Layer)**

Thermal underwear, NO COTTON, comes in several weights (and insulation values) - silk/tech silk weight, medium, heavy, polar/expedition and then goose down. Each level is designed for a different level of cold. Silk/tech silk is the lightest weight and is for cool days when there is a possibility of sweating, it will wick away the sweat while also providing some insulation, thereby keeping you warmer than without any thermal underwear. Heavier weights will keep you warmer at colder temperatures and will also wick away any sweat. Goose down thermal underwear should be worn with a silk/tech silk weight set to wick away any sweat. If you are going to wear briefs or boxers beneath your thermal underwear these should be of a "technical" or synthetic fabric that is designed to wick sweat away from your skin, the same applies



**Polar Weight**



**Heavy Weight Zip-T**

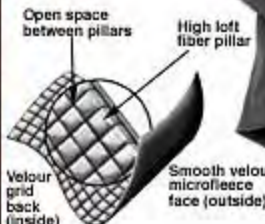

Power Dry now available in Cabela's Exclusive Seclusion 3D Camo



**Medium Weight**

**Tech Silk Weight**



**Men's Silk/Wool Blend Underwear**



**Men's Silk Underwear**



**Mock-T**



**Boxers**



**Balaclava**



**Glove Liner**



**Sock Liner**



**Bibs**



**Zip-Top**



**Pants**



**Balaclava**



**Socks**

for T-shirts worn over thermal underwear.

**POLARTEC**  
ScenELIMINATOR<sup>®</sup> MIP SERIES  
MAXIMUM THERMAL PROTECTION

**BIG and TALL**  
up to **5XL**



# First Aid and Medical Kits

There are lots of first aid kits out there, ranging from pocket first aid kits to EMT kits. Many kits are poorly thought out or contain poor quality contents. You should have a small pocket first aid kit that is easy to get to for minor cuts, scrapes and pain in every pack. You should also have a more complete first aid kit. Some people have several pocket first aid kits and then a larger, more complete kit. Along with your larger kit you should have a good first aid book.

In researching this page we came across a very good article written by an ER doctor on what he keeps in his first aid kit and why. Below are some quotes from his article, available at [www.aeromedix.com](http://www.aeromedix.com), along with the contents of his first aid kit. Dr. Blue not only wrote this article, he also sells kits very similar to the one he carries. At first glance the price of his first aid kit, \$333.00 (which includes about \$100.00 for the bag itself), seems high but when you compare it to other EMT kits on the market it really isn't.

First some information about Dr. Blue from the article on [www.aeromedix.com](http://www.aeromedix.com):

*Over the years, Dr. Blue has assembled his own traveling medical kit for dealing with on-the-road emergencies, based on his long experience as an emergency room doc, frequent traveler, pilot, outdoorsman, and dad. He offers details of exactly what's in his kit, why each item is there, and how to assemble a really good kit of your own.*

*Brent Blue M.D. is a Senior Aviation Medical Examiner and was the physician for the U.S. Acrobatic Team at the World Competition in 1994.*

This is from the main page of the medical kit available:

*Developed by Aeromedix.com founder and emergency room physician Dr. Brent Blue, this is the finest and most versatile first aid kit you can buy.*

*Do you carry a first aid kit in your airplane or car? One of the things that has always driven me crazy about the commercial first aid kits that you find in drugstores and pilot supply catalogs is that they're filled with crap that is totally useless ... and sometimes even harmful. Over the years, I have assembled my own traveling medical kit for dealing with away-from-home emergencies, based on my long experience as an emergency room doc, frequent traveler, pilot, outdoorsman, and dad. Now you can buy a kit of your own substantially identical to the one I carry when I travel.*

*Most first aid kits contain too much special-purpose stuff and not enough multi-purpose stuff. When weight and space are at a premium, it's essential to choose medications and other items which can be used to deal with multiple problems. For instance, antibiotic eye drops can be used in the ear, but eardrops cannot be used in the eye.*

Below is the contents of Dr. Blue's first aid kit:

Item	Qty
1"x3" Woven (Swift Brand)	30
3" Cotton Tip Applicators Sterile 2's	30
3"x4" Non-Ad Pad	5
4x4 Gauze	40
7/8" Plastic Spot (Swift Brand)	30
Arizona Sun SPF 30 1oz	1
Aypanal Extra Strength (Acetaminophen) 2's	32
Benadryl Caps 25mg	24
Betadine Pads	20
Betadine Solution 1/2oz	2
Blistex	1
Buffered Aspirin 2'S	32
Cedaprin (Ibuprofen) 200mg 2's	32
Character Strips 3/4"x3"	30
Co-Flex 3"	1

Cold Pack	2
Cough Drops Menthol Eucalyptus	24
Dermicel Tape 1"	2
Dermicel Tape 2"	1
Dramamine	1
Ear Plugs Max (NRR 33) Pr's	4
Elastic Bandage 2"	1
Elastic Bandage 4"	1
Elastic Bandage 6"	1
Electrolyte Tablets	32
Eye Wash 4oz	1
Fingertip "8" Woven (Swift Brand)	30
First Aid Book	1
Flexicon 2"	2
Flexicon 4"	2
Flexicon 6"	2
Folding Paper Cups	
Gloves Nitrile (Blue) Large PR's	2
Golf Towels ultra Compressed	
Hydrocortisone 1% Foil Pack	5
Imodium AD	1
Kleenex	2
Knuckle Woven (Swift Brand)	30
Kotex Maxi Pads (Individually Wrapped)	2
Liquid Children's Tylenol 2oz	1
Mastisol	4
Moleskin 4"x12"	1
Mosquito Hemostat 4"	1
Natrapel (deet free repellent) 2oz	1
Nu-Tears 1/2oz	1
Pepto Bismol Tablets	48
Porous Cloth Tape 1"	2
Porous Cloth Tape 2"	1
Safety Pins Assorted	1
Sam Splint	1
Scalpel Blade #10	3
Small EMT Shears	1
Steri-strips 1/4x1-1/2 (Envelope of 6)	1
Steri-strips 1/4x3 (Envelope of 3)	1
Steri-strips 1/8x3 (Envelope of 5)	1
Sterile Needles 18guage	3
Tampons	2
Tee Tree Oil (Burn Away)	1
Tongue Blade (non-sterile) 3/4" x 6"	15
Trash Bags 20qt	4
Triangle Bandage	3
Urine/puke bag (#1 Travel John)	1
Vacuum Packed Wash Cloths	
Vionex No Rinse Jell 4oz	1
Wash Up Towelettes	30
Zip Lock Bags 12" x 15"	2

Below is a picture of the contents of Dr. Blue's kit:



There are other items you will want to pack. Various supports, such as wrist and knee with metal staves in them. Various band aids, sanitary napkins/pads are good for absorbing blood. Plastic food wrap can be used to keep a wound clean and aid in keeping it dry. Lots of 92% isopropal alcohol and hydrogen peroxide to keep wounds clean. Pepto Bisumal or other stomach remedies to help with cramps and other intestinal issues - dehydration can kill quickly. Small packets of distilled water can be used to clean out wounds. Electrolyte powder and salt tablets help in high activity periods and when dehydrated. Dental kits can also be very handy to have.

More specialized items like blood pressure cuffs and minor surgery kits may be good items to have for the long term. These items may be of use to other members of your group who have the training to use them, and could save your life. Nitro-Pak is a well known source of survival and emergency preparedness supplies and carries surgery and injection kits such as those below:



Make sure that you do have prescription drugs you require, at the very least you need a one month supply, more is better of course. A bottle of multi-vitamins should also be included in your medical kit.

Additional quantities and specialty items can be kept in a larger box or bag, this allows you to quickly grab the primary first aid kit and makes sure that you always have a good kit with you.

Another good site for medical kits is [www.adventuremedicalkits.com](http://www.adventuremedicalkits.com). You can also buy Adventure Medical Kits from [www.cabelas.com](http://www.cabelas.com).

Don't forget to take care of your pets. Cabelas's has a number of first aid kits and supplies for dogs. You can also get first aid kits and supplies from Doctors Foster & Smith - [www.drsofostersmith.com](http://www.drsofostersmith.com).

One thing rarely seen in any of these kits is a "casualty blanket" which is used by the US military. In essence these are OD green versions of the "Sportsman's Thermal Blanket" listed on other gear pages. Some of these kits do have the light weight, and somewhat flimsy, emergency or "space" blankets. Hitting the search engines for "casualty blanket" will turn up a number of retailers if you want the official military version.

Mentioned above is distilled water. These can come in the form of Coastguard approved survival water pouches. A block of Coastguard approved survival rations can also be included in medical kits for those times when someone is not able to eat solid food. These survival rations are good for 5 years and can be dissolved in water to provide nutrition to the injured.

Boxes of Nitrile gloves, more puncture proof than latex without the allergic reactions that some people have to latex, can be found at any drug store and at Wal-Mart. NP-95 masks are widely available and will help prevent you from contracting any airborne germs.

The books "Where there is no doctor", "Where there is no dentist" and "Comprehensive Guide to Wilderness & Travel Medicine 2nd edition" among others are handy to have, as is a good book on herbal remedies with pictures or illustrations. When all else fails you may have to fall back on trying herbal cures, when it is a matter of try a herbal remedy that may work or don't try the herbal remedy and die for sure the choice is fairly clear - remember that many medicines are derived from plants and that the pharmaceutical industry invests millions into researching herbal remedies and then making synthetic versions they can make money off of.

Don't forget you may be able to talk with your family doctor, or veterinarian for your pets, about broad based anti-biotics and other prescription (or doctor) only items. You will have to feel out your doctor - broach the subject of preparing and cite the government's instructions to have emergency supplies on hand, ask for the doctor's advice on what items you should have, then bring up prescription (or doctor) only items and your desire to have some on hand just in case. Some doctors will provide you with prescriptions for a course of common prescription anti-biotics while others won't. This is why it is important to speak with them and feel them out first, some doctors may even suggest that you may want to have a course or two of certain prescriptions. Some doctors will provide you with samples instead of writing you a prescription, either way you have the medication.

Do some research into EMT and paramedic kits, compare the contents with those listed in Dr. Blue's kit and the ones from Adventure Medical Kits and you can build your own kit. Compare prices to what you will pay at retail, the costs of these readily available kits, and make your decision on which path you will choose - build your own or buy a complete kit. Look at travel sites - many have surgical, suture and injection kits for travelers going to places that may not have sterile instruments, these can be a great resource for kits that are pre-packaged or that may be difficult to obtain... plus the pre-packaged kits can be easily vacuum sealed for long term storage.

# Day Pack

Everyone should have a day pack that they keep near at hand at all times. This is the kit you grab when you go into the woods, on a hike, etc. The size should be about 1000 cubic inches of space, plenty of room for the essentials. The pack can be a backpack - preferably a hydration pack or a waist pack. It should be well made to allow for years of use and comfortable enough to wear all day. Below are a few examples of what is available. The Camelbak Hawg, bottom left, is the most expensive but it does have the ability to have additional US military MOLLE and ALICE pouches attached.



If your pack does not have a built in hydration bladder, such as the Camelbaks, then you should have at least two quart bottles or canteens.

In your pack you should keep a few key items:

- small first aid kit
- small mess kit, or canteen/cup/stove (see Basic Pack on the left)
- water filter/purifier (see Basic Pack on the left)
- poncho and liner for wet weather and shelter (see Basic Pack on the left)
- a compass
- one pair of underwear
- two pairs of socks
- one T-shirt, synthetic
- one pound hatchet or machete (see Basic Pack on the left)
- some lightweight rope such as parachute cord
- 3 MRE or dehydrated/freeze dried meals
- a basic survival kit (signalling, fire starting, etc - see below)
- windbreaker or lightweight sweater or fleece
- multi-tool, locking folder knife & 6 inch fixed blade knife
- flashlight
- toilet paper
- small bar or bottle of soap
- face cloth and/or hand towel
- a "Sportsman's Space/Thermal Blanket" is optional (see Sleeping Gear on the left)
- lightweight, compressable pants and long sleeve shirt are optional
- some snack type foods are optional)



The Pocket Survival Kit available at Adventure Medical Kits - [www.adventuremedicalkits.com](http://www.adventuremedicalkits.com), made by Doug Ritter - [www.dougritter.com](http://www.dougritter.com), is one of the better pocket survival kits out there. Below are two pictures of the kit. See Doug Ritter's site for more information on this kit along with a lot of supplemental information.





You may want to keep a few other items in your pack if room permits. Each person will have certain things they like to have with them when they are heading into the forest - some will take a small shovel and folding saw while others will include a tarp. When you are in the wilderness or just traveling around town accidents and emergencies can come up, some version of this kit should be with you at all times possible.

The goal of this pack and the items contained in it are to be light enough that you keep them with you at all times while providing the basic essentials to stay alive should some unexpected situation come up and you have to spend a night or two in the forest.

## Odds & Ends - Miscellaneous Equipment and Clothing

Now we will try to tie up loose ends and make suggestions on equipment, clothing and other things not covered on the other pages. On our other pages we have tried to cover as much as possible on some key areas, from the essentials to optional equipment. Given that the concept of survival is one of long term there are any number of things that may not come to mind immediately, plus we want to make things as easy as possible in your planning.

Although there is no way we can cover every possible scenario, gear or option we will try to cover things that we haven't covered on the other pages. As in any plan, you have to balance what you want, what you need and what you can afford or improvise. Use this page and the other pages in the Suggested Gear and Clothing section to guide you and help you get the gear you need to cover the situations you may need to contend with.

### **Clothing & footwear**

When it comes to non-winter clothing you want to pick good quality items that will last a long time. Shirts and pants can be made fairly easily, but socks and underwear are harder to make. Stock up on socks and underwear, they don't take up much room and sure beat itchy wool next to your skin. Buy thread and needles, buttons and snaps (including snap repair kits from leather working or hobby stores).

As we've mentioned before a good pair of boots are a must. A good pair of boots will last for years and can be re-soled, stopping in at your local shoe repair place to pick up a pair of replacement soles doesn't cost much and ensures that you can replace the soles on your boots when they wear out. If you have special needs for your footwear such as wide or narrow feet or orthopedic footwear try to get extras. Well made running shoes can be found for low cost, COSTCO's brand of plain white leather tennis shoes are well made and at \$15 are hard to beat price wise. For general use cheaper, less durable footwear is ok, but for any distance you want good footwear... you want to know that they will last without causing any aches or pains.

### **Furniture, hygiene & misc. household things**

Folding camp chairs are lightweight, easy to transport and give you some furniture to sit on. Buy good quality ones with a sturdy frame, the fabric can always be replaced in the future if needed. There are chair, rocker and lounge versions available. Folding camp tables are another option.

When it comes to lighting there are a lot of alternatives. Kerosene lanterns, tiki torches, LED flashlights and lanterns, propane lanterns and more. Most of these require some sort of fuel or energy to produce light. You can get battery operated lanterns and lights and rechargeable batteries with a solar recharger. Another option is to get solar powered patio or yard lights, these can be used inside as long as you remember to put them in a window or outside so that they recharge. If getting solar powered patio lights the best bet would be to get metal ones, these will last longer than plastic. Candles are always an option, there are any number of candle lanterns that use "tea light" candles.

Many people forget simple things like soap, tooth paste, tooth brushes and other hygiene and cleaning items. You not only have to clean yourself but you have to clean your clothes and dishes. The Cal Ben Soap Company - [www.calbenpuresoap.com](http://www.calbenpuresoap.com) makes getting it all at once fairly easy and relatively cheaply. Made from 100% natural ingredients it is generally highly thought of. Grab a back brush from the store, it makes getting your back clean easier and comes in handy if you're injured. Those solar shower bags are an option. Make sure you have one or two wash basins, good quality plastic totes can be used for this once you get there and unpack what was in them. A washboard, clothes pegs and clothes line should round out your washing and hygiene kit. Don't forget to pack toilet paper, the more you can get the better (they take up less room if vacuum sealed and they stay dry!). You may want to get one of those plastic bucket type portable toilets, a spare toilet seat to use in an outhouse isn't a bad idea either.

### **Food & water**

Although we plan on raising our own food, depending on the time of the year we may be looking at close to a year before we can expect a harvest. Plan on things being lean in this respect and get as much food as you can afford and can fit into your vehicle. Canned goods are fine, and the cheapest way to build up a food supply but they are bulky and heavy. You may want to consider freeze dried/dehydrated or military MREs. Canned food and MREs are temperature sensitive meaning that

changes in temperature can affect how long the food will keep. Freeze dried/dehydrated food is less temperature sensitive. Get as much food as you can get and your vehicle can safely transport, ideally a year supply for every person in your immediate family. It is better to have food that you can not transport than to not have enough food. If you start with canned goods now you will be amazed at how quickly they accumulate. STORE WHAT YOU EAT. Make sure that before you buy a case of food that you try some and like it. Most retailers will have sample packs or you can order individuals of each item you are thinking about. Below are links to a number of manufacturers and retailers:

Freeze Dry Guy - [www.freezedryguy.com](http://www.freezedryguy.com)  
Mountain House - [www.mountainhouse.com](http://www.mountainhouse.com)  
AlpineAire - [www.alpineaire.com](http://www.alpineaire.com)  
Ready Reserve Foods - [www.readyreservefoods.com](http://www.readyreservefoods.com)  
Freeze-Dry Foods - [www.freeze-dry.com](http://www.freeze-dry.com)  
HeaterMeals - [www.heatermeals.com](http://www.heatermeals.com)  
Long Life Food Depot - [www.longlifefood.com](http://www.longlifefood.com)  
Nitro Pak - [www.nitro-pak.com](http://www.nitro-pak.com)  
Ready Reserve Foods - [www.readyreservefoods.com](http://www.readyreservefoods.com)  
Sopakco - [www.sopakco.com](http://www.sopakco.com)  
Walton Feed - [www.waltonfeed.com](http://www.waltonfeed.com)  
Wornick - [www.wornick.com](http://www.wornick.com)  
Ameriqua - [www.ameriqua.com](http://www.ameriqua.com)  
eFoodsDirect - J. Michael Stevens Group - [www.efoodsdirect.com](http://www.efoodsdirect.com)

Don't forget to buy seeds, heirloom or other seeds that will allow you to save seeds and will grow the next year are the best bet. If you can find them, try to get seeds for plants that can be harvested in 90 days or less, this is the least amount of time we will have to grow and harvest crops, shorter growing times will allow for multiple harvests in the growing season. Crops that take more than 90 days will have to be started in some sort of green house or indoor setting and then transplanted into gardens or fields. See the Plant Hardiness Zones link on the left for more information. A great site to brush up on gardening and farming is Dave's Garden - <http://davesgarden.com>, a great book to have is *Encyclopedia of Country Living* by Carla Emery - [www.carlaemery.com/country-living-book.htm](http://www.carlaemery.com/country-living-book.htm). Below are some links to sites that sell heirloom seeds, you will have to browse their sites (or contact them) to find crops with a 90 day or less plant to harvest cycle:

#### US sites/retailers

Baker Creek Heirloom Seeds - [www.rareseeds.com](http://www.rareseeds.com)  
[www.heirloomseeds.com](http://www.heirloomseeds.com)  
The Victory Seed Company - [www.victoryseeds.com](http://www.victoryseeds.com)  
Seed Savers Exchange - [www.seedsavers.org](http://www.seedsavers.org)  
Seeds Trust - [www.seedstrust.com](http://www.seedstrust.com)  
Amishland Heirloom Seeds - [www.amishlandseeds.com](http://www.amishlandseeds.com)  
Heirloom Acres Seeds - [www.heirloomacres.net](http://www.heirloomacres.net)

Although Forestfarm - [www.forestfarm.com](http://www.forestfarm.com) does not say whether they sell heirloom seeds you can search via US Hardiness zone.

#### Canadian sites/retailers

Agrestal Organic Heritage Seeds - [www.agrestalseeds.com](http://www.agrestalseeds.com)  
Gardeners Web - Alberta Nurseries - [www.gardenersweb.ca](http://www.gardenersweb.ca)  
Green Space Design - [www.organic-seeds.ca](http://www.organic-seeds.ca)  
Ontario Seed Company - [www.oscseeds.com](http://www.oscseeds.com)  
Prairie Garden Seeds - [www.prseeds.ca](http://www.prseeds.ca)  
The Garden Path - [www.earthfuture.com/gardenpath/](http://www.earthfuture.com/gardenpath/)  
Stellarseeds - [www.stellarseeds.com](http://www.stellarseeds.com)  
Sunshine Farms - [www.sunshinefarm.net/cart/index.php](http://www.sunshinefarm.net/cart/index.php)

For a list of heritage, organic and open pollinated seeds see Seeds of Diversity - Canada's Heritage Seed Program - [www.seeds.ca/rl/rl.php](http://www.seeds.ca/rl/rl.php). The top part of the page lists Canadian growers/retailers while the bottom part of the page lists US growers/retailers.

When it comes to water there are lots of options available. From storing 20 oz bottles of water to one gallon bottles of water or 10 gallon jugs. You can buy the water already bottled or bottle your own. There are also 4 oz packets of Coastguard approved water. Some people store water in food grade plastic drums up to 55 gallons in size. Keep in mind that water weighs about 8 pounds per gallon, storing large amounts of water can make it difficult to transport. On the Cooking Gear and Basic Pack pages (see menu on left) we have suggested a few water purifiers. These are not the only options out there. The options shown below either require batteries or have limited effectiveness/lifespan.



We've covered storing and growing food but we have not touched on gathering wild plants, hunting or fishing. Gathering wild plants is a skill you can develop over time. One way to develop this skill is to get some good books on wild plants in your area. If you get books on other areas these can be kept with your gear and will provide the information you need when/if you have to leave your usual area. Everyone should have a basic fishing kit that includes a rod, reel, hooks, lures, etc. There are decent telescoping rod and reel sets that come with some basic hooks and lures. A slingshot is small and easy to pack and won't raise any eyebrows, they are also fairly cheap as is shot (basically steel ball bearings), both are readily available at Wal-Mart in the sporting goods section. Slingshots are good for small game such as rabbits. Bows and crossbows are another option for various sized game. BB and pellet guns can be used for small game, pellets and BBs are very cheap, with better airguns running to \$500 but with much higher velocities than your standard Daisey or Crossman airgun. If you look around at sites such as Cold Steel - [www.coldsteel.com](http://www.coldsteel.com) you will find that spear heads are fairly easy to find, you can always find a good piece of wood to make the spear shaft out of.

Now we come to firearms. Of course guns can be used for hunting. Keep in mind that local, state/provincial as well as US/Canadian laws differ greatly when it comes to firearms. Because of that we will keep mention of firearms to a minimum. When it comes to hunting guns the most used are shotguns and rifles. The most common shotgun rounds are 12 guage and .410. For rifles there is the .22 for small game and .303, 30-30, and .308 for larger game. The .303, 30-30 and .308 will take down most large game in North America. This minimal mention of firearms is not to be treated as the last word on firearms, check with family, friends, etc for more information. This is just meant to give you a very basic primer.

### Batteries and small electrical items

There are any number of things that we would like to bring with us that require batteries or electricity. For battery powered items this isn't such a huge issue. Rechargeable batteries and a solar recharger will allow you to use these items. Make sure you have lots of good quality rechargeable batteries. You can also use a regular AC recharger along with a car battery, AC-DC inverter and a small solar panel to recharge the car battery.





For a large selection of inverters, backup power and related items see Xantrex - [www.xantrex.com](http://www.xantrex.com).

### Communications

Communications, both receiving and transmitting can bring in a lot of information. Having a standard AM/FM radio is one way to get information, but there are a couple of better options. A good radio to keep you informed is the Kaito KA009 - [www.kaitousa.com/KA009.htm](http://www.kaitousa.com/KA009.htm) which has AM/FM/Shortwave/Weather/TV(2-13)/Aviation bands and can be powered by regular batteries, AC adapter, crank, solar. The reception on these radios is very good, and at a price of \$55 from the Kaito website, less if you shop around, very affordable. Kaito has a number of very good radios, in fact the US military has ordered tens of thousands of Kaito radios for use in Iraq. A radio such as this, whether the Kaito or another brand, is a must in any emergency situation. Another option is to get a scanner which will cover just about all of the public radio bands. Scanners can be more expensive but they do have wider coverage.

For the ability to transmit and to keep in touch we suggest FRS/GMRS radios, these can be used to keep in touch with members of your family over short distances (no more than 14 miles). Optional headsets allow you to have hands free communication if your family is using more than one vehicle. With other members of your group having FRS/GMRS radios these will come in handy once you reach your destination. A good CB, with upper/lower SSB (Single Side Band) preferably, is a good thing to have on the road. You can listen in to the truckers to find out road conditions ahead of you and to keep up on any breaking news. On long hauls it can also help keep you company and keep you awake. CBs generally have a range of about 5 miles - terrain, antenna, output power affect transmission and reception. Although you may be tempted to get a handheld CB be advised that the reception and transmission on these is poor. Make sure you have a good quality antenna, the large metal whip antennas provide the best reception. A ham radio, 2m (2 meter) can also come in handy. With the ability to transmit and receive from much further than FRS/GMRS or CB, these can literally save your life. In the US you do not need to have a FCC license to own a ham radio or to listen but you do need a license to transmit or talk. The exception to the license rule is in life or death emergencies, in this case the FCC will not come after you for transmitting/talking without a license. 2m handheld radios can be found for under \$100 used, often as little as \$50 in good working condition. Keep in mind that once again, the handheld models will not have the transmitting power of "base" models, although an amplifier can resolve this problem. Marine radios can use the same antenna as a 2m ham radio, and although they are generally used on the water there are certain bands that can be used on land. It is also likely that very few people will be listening to marine radio frequencies on land so it can be an alternative to CBs or FRS/GMRS radios when your family is using more than one vehicle.

### Getting around in the winter

Getting around in the winter can be a chore that saps your energy with seemingly little distance traveled. Winter gear can weigh a lot when you get into all of the things you need to stay alive and comfortable. Snow shoes can be used to keep you from sinking into the snow, but the going is slow. Cross country skis will allow you travel longer distances at a quicker pace but take more practice to master. To help with hauling your gear you may want to consider a sled or toboggan that you can pull behind you. Most militaries that practice winter maneuvers use a combination of cross country skis and sleds, the sleds are hooked to harnesses worn by one person in front and one person in the rear... in this way the person in the back makes sure that the sled does no overtake the person in the front. Sleds can make carrying your gear much easier and can carry more than you can.

## **Rope and climbing gear**

Rope comes in handy in many ways. Everything from basic twine, parachute cord to strong climbing rope has a use. A couple of hundred feet of parachute cord can be bought for a small amount and has as many uses as duct tape. Common rope is very useful for many things from tying things down to making shelters. Climbing rope, 50 to 100 feet along with a basic climbing kit consisting of belt, hammer, some carbiners and pitons can make sure that any climbing you have to do is much easier and safer.

## **Leisure and entertainment**

We will have times when we have nothing to do or when we can't do anything. If you don't plan for these times you could find yourself getting bored or depressed, which can affect your survival or just your happiness. With space at a minimum and weight an issue you may be thinking that there is no way you can pack anything to pass the time, you would be wrong. Aside from a favorite book there are cards, travel versions of popular games such as chess, checkers and backgammon among others. These pocket or travel games can be found in dollar stores, toy stores and in some auto parts stores. A book of card games goes well with a couple of decks of cards. There is also the GURPS role playing game from Steve Jackson Games which provides a basic set of universal rules that can be applied to multiple settings such as fantasy, wild west, etc... one book and a set of dice can provide years of entertainment (and teaching if you plan it right).

Musical instruments of all types, from penny whistles to guitars and drums can be part of any long term kit. These don't have to be the best quality if all you're looking for is to pass the time with family and friends. There are also small instruments that can be packed in your kit and carried with you.

## **Gas masks, etc**

For those who want to prepare for every eventuality there are gas masks, nuclear radiation detectors as well as full NBC hazard suits. For gas masks, Scott - [www.scotthealthsafety.com](http://www.scotthealthsafety.com) and MSA - [www.msanorthamerica.com](http://www.msanorthamerica.com) are widely recognized as being the best. Nitro-Pak - [www.nitro-pak.com](http://www.nitro-pak.com) and Survival Logistics - [www.survivallogistics.com](http://www.survivallogistics.com) have a number of items beyond gas masks. If you want radiation detectors the place to go is Nuk Alert - [www.nukalert.com](http://www.nukalert.com) or KI4U, Inc - [www.radmeters4u.com](http://www.radmeters4u.com), same company different websites, both have a lot of information on radiation and related preparedness.

## **Transport Options**

You may want to consider a small trailer to keep everything stored in and ready to go. Trailers only take a few minutes to hook up. There are a number of other options available.

## **Finishing Up**

In the end one way to figure out the things you may forget is to go through your house and list everything that you use on a daily basis. Make a separate list for each room. Once you have a list of everything go over each list and see what things you would be willing to live without. Then go through the remaining items and see which ones require power of some sort and note a manual alternative.

Although you would need a large vehicle and/or a trailer to transport everything found on the **Suggested Gear and Clothing** pages we have provided these items to give you an idea of the types of things you *will* need and some items that are optional and that you may want to bring. By no means are the items listed on these pages a must, each person or family must make decisions as to what items they consider essential and which items they can actually fit in their vehicles. Finances for each person or family differs which also factors into what items they can get before hand. These pages are here to provide ideas and goals to allow everyone to survive in as much comfort and with as much ease as possible.

**SurvivalistsSite.com**

[www.survivalistssite.com](http://www.survivalistssite.com)

Message Forums - Blogs - Community Pages - Chat - RSS & Atom Syndication