

**MUNITIONS SUPPORT IN  
THE THEATER OF  
OPERATIONS**

**HEADQUARTERS, DEPARTMENT OF THE ARMY**

DISTRIBUTION RESTRICTION: Approved for public release; distribution is unlimited.

# MUNITIONS SUPPORT IN THE THEATER OF OPERATIONS

## Table of Contents

PREFACE .....	iii
<b>CHAPTER 1 INTRODUCTION TO MUNITIONS SUPPORT .....</b>	<b>1-1</b>
Purpose and Scope .....	1-1
Munitions Support Mission .....	1-1
Supported Units .....	1-2
Support Environment .....	1-2
CSS Characteristics .....	1-2
Planning Guidance .....	1-4
Munitions Strategic, Operational, and Tactical Logistic Levels .....	1-4
Support Structures .....	1-7
<b>CHAPTER 2 MUNITIONS SUPPORT STRUCTURE .....</b>	<b>2-1</b>
Purpose and Scope .....	2-1
Ammunition Surge Support .....	2-1
Support Structure Overview .....	2-1
Ammunition Support Activities .....	2-1
Ammunition Units .....	2-1
Ammunition Support Team .....	2-15
Munitions Flow in the Theater .....	2-17
Aerial Resupply .....	2-18
Command and Support Relationships .....	2-19
Functional Responsibilities .....	2-19
<b>CHAPTER 3 MUNITIONS PLANNING AND EXECUTION .....</b>	<b>3-1</b>
Purpose and Scope .....	3-1
Conventional Ammunition Allocations .....	3-1
Logistics Preparation of the Theater .....	3-3
<b>CHAPTER 4 RETROGRADE OPERATIONS .....</b>	<b>4-1</b>
Purpose and Scope .....	4-1
Redeployment and Retrograde .....	4-1
Destruction of Ammunition .....	4-3
Ammunition Maintenance .....	4-4

Physical Security .....	4-5
Transportation and Storage .....	4-6
<b>CHAPTER 5 EXPLOSIVE ORDNANCE DISPOSAL SUPPORT STRUCTURE</b> .....	<b>5-1</b>
Overview .....	5-1
EOD Role .....	5-1
EOD Incidents .....	5-2
Control Procedures .....	5-3
Transition to War .....	5-3
Support Structure and Operations .....	5-3
Host Nation Interface .....	5-7
Communications .....	5-7
<b>CHAPTER 6 THE ENVIRONMENT, SAFETY, RISK MANAGEMENT, AND MAINTENANCE AND SURVEILLANCE OPERATIONS</b> .....	<b>6-1</b>
<b>SECTION I THE ENVIRONMENT</b> .....	<b>6-1</b>
Environmental Policy and Goals .....	6-1
Stewardship in the Operational Environment .....	6-2
<b>SECTION II SAFETY</b> .....	<b>6-4</b>
Responsibilities .....	6-4
Standing Operating Procedures .....	6-5
Accident Reporting .....	6-5
<b>SECTION III RISK ASSESSMENT AND MANAGEMENT</b> .....	<b>6-6</b>
Integrating Assessment Techniques .....	6-6
Five-Step Process .....	6-6
<b>SECTION IV MAINTENANCE AND SURVEILLANCE OPERATIONS</b> .....	<b>6-6</b>
Maintenance Operations .....	6-6
Surveillance .....	6-7
Surveillance Records and Reports .....	6-10
Destruction Plan .....	6-11
Unserviceable Ammunition Storage .....	6-12
Suspended Ammunition Storage .....	6-12
Captured Enemy Ammunition Storage .....	6-13
<b>APPENDIX STANDARD ARMY AMMUNITION SYSTEM-MODERNIZATION (SAAS-MOD)</b> .....	<b>A-1</b>
<b>GLOSSARY</b> .....	<b>Glossary-1</b>
<b>REFERENCES</b> .....	<b>References-1</b>
<b>AUTHENTICATION</b> .....	<b>Authentication</b>

---

**PREFACE** This FM prescribes doctrine for munitions support. It explains in general terms how munitions units operate and how they interact to provide munitions to the user. It is the basis for munitions doctrine, materiel, training, and organizational development. This manual addresses munitions unit missions, operations, and interactions between the various levels of munitions support.

FM 9-6 explains to combat arms, combat support (CS), and combat service support (CSS) commanders and their staffs how and where they receive munitions support. It establishes guidelines and procedures for munitions unit commanders and their staffs operating the munitions support structure.

Also, this manual introduces two very important doctrinal changes. First, it incorporates the maneuver-oriented ammunition distribution system, palletized load system (MOADS-PLS) into the ammunition support structure as Army doctrine. This allows for the extensive use of PLS for the distribution of ammunition. Second is the modular ammunition platoon concept. There are two types of modular platoons: heavy lift and medium lift. The heavy lift platoon (HLP) is best suited for port, theater storage area (TSA), and corps storage area (CSA) operations. Medium lift platoons (MLPs) operate in TSAs and CSAs when needed and are designed to operate ammunition supply points (ASPs). These platoons are capable of deploying and operating independently from their company headquarters, but require external support for sustainment. They allow the Army to effectively take advantage of technology and the PLS. The PLS incorporates strategic and mission configured loads (MCLs). These palletized loads are capable of being shipped to TSAs, CSAs, and ASPs. The type and number of platoons deployed is based on mission, enemy, troops, terrain and weather, and time available (METT-T) and the commander's intent. Modular units provide a flexible design tailorable to the theater commander's intent. They give the theater commander the capability to expand and contract the ammunition supply capability when and where needed to meet operational requirements.

This publication implements the following standardization agreements (STANAGs):

[STANAG 2034](#). *Land Forces Procedures for Allied Supply Transactions*, Edition 4. 20 December 1982.

[STANAG 2135](#). *Procedures for Emergency Logistics Assistance*, Edition 3. 12 February 1982.

[STANAG 2827](#). *Materials Handling in the Field*, Edition 2. 12 February 1980.

[STANAG 2829](#). *Materials Handling Equipment*, Edition 2. 20 March 1978.

[STANAG 2834](#). *The Operation of the Explosive Ordnance Disposal Technical Information Center (EODTIC)*, Edition 2. 26 March 1990.

[STANAG 2928](#). *Land Forces Ammunition Interchangeability Catalogue in Wartime*, Edition 3. 9 June 1995.

[STANAG 2961](#). *Classes of Supply of NATO Land Forces*, Edition 1. 11 December 1984.

The proponent for this publication is Headquarters, United States Army Training and Doctrine Command

(HQ, USATRADO). Send comments and recommendations on [DA Form 2028](#) (or in 2028 format) directly to Commander, USACASCOM&FL, Training Directorate, ATTN: ATCL-AO, 801 Lee Avenue, Fort Lee, VA 23801-1713.

Unless this publication states otherwise, masculine nouns and pronouns do not refer exclusively to men.

---

---

## CHAPTER 1

### INTRODUCTION TO MUNITIONS SUPPORT

*"A soldier can survive on the battlefield for months without mail, weeks without food, days without water, minutes without air, but not one second without ammo!"*

**(Author Unknown)**

### PURPOSE AND SCOPE

Munitions is the dominant factor in determining the outcome of combat or stability and support operations (SASO). It is a critical component of fire and maneuver operations performed by the force projection Army. Munitions provide the means to defeat as well as destroy the enemy. They give the force the ability to block, screen, or protect itself.

The limited quantity of our modern munitions and weapons systems requires that munitions are managed to ensure availability and enhance combat readiness. In the future, most major military operations will be joint or coalition and based on unexpected contingencies. These operations will require the munitions logistic system to be modular, tailorable, easily deployed, and flexible.

This chapter introduces the munitions support structure and its mission. It addresses the following topics:

- Supported units.
- Support environment.
- Munitions support considerations.
- Sustainment imperatives.
- Munitions strategic, operational, and tactical interfaces.
- Transportation interfaces.

### MUNITIONS SUPPORT MISSION

Our national security needs form the basis of our national military strategy. We must support the four basic demands that are fulfilled by the military. They are:

- Guarantee strategic deterrence and defense.
- Exercise a forward presence in vital areas of the world.
- Respond effectively to a crisis.
- Retain the capacity to reconstitute forces.

The Army's ability to react and sustain the battle improves the chances of conducting a successful operation. The munitions soldier's mission is to ensure munitions arrive in the hands of the warfighter in the right quantities and proper types at the decisive time and place. Munitions logistic plans must mesh the tactical level

commander's plan to the operational and strategic plans. This helps ensure timely support and sustains the operation.

Commanders, with advice from logis-ticians, tailor support packages to meet theater requirements for a variety of strategic contingency plans. The use of modular ammunition units increases our ability to meet theater munitions requirements. Modular units will be deployed based on operational needs and will help ease strategic lift requirements.

The Army's ability to meet its force projection requirements calls for highly mobile, multifunctional organizations capable of projecting munitions support anywhere in the world. The measure of success is the ability to accomplish the following effectively and efficiently:

- Provide munitions to operational and tactical commanders.
- Support current and future gener-ations of combat power anywhere in the world.
- Sustain maneuver forces in a wide variety of mission profiles.
- Support the tenets of Army oper-ations doctrine.
- Retrograde munitions to the conti-nental United States (CONUS) or other theaters of operations.

### **SUPPORTED UNITS**

Every unit on the battlefield requires munitions. Providing sufficient types and quantities at the right place on time is critical to the success of combat operations and SASO. When the Army fights as part of a joint, multinational, or combined force, US Army munitions units may support other US services and allied forces.

### **SUPPORT ENVIRONMENT**

Ammunition units must push munitions forward on the battlefield. At the same time, they must maintain minimum essential stocks throughout the distribution system to retain maximum flexibility and mobility for future combat operations. The need to protect ammunition support activities (ASAs) from rear area threat activities complicates muni-tion support operations. Military Police (MP) units augment ammunition units to provide security for ASAs.

Ammunition units may find themselves close to combat. In such situations, units must continue to provide essential munitions support while relocating away from the threat. Disruptions from threat forces are likely to occur throughout the theater of operations, from brigade support areas to deep within the communications zone (COMMZ).

### **CSS CHARACTERISTICS**

The tenets of Army operations doctrine, as presented in [FM 100-5](#) (see Figure 1-1), are basic to operational and tactical success on the battlefield. These tenets also establish the framework for organizing sustainment.

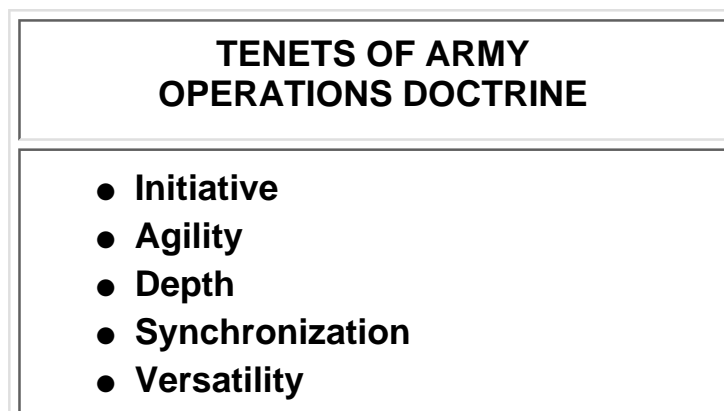

### Figure 1-1. Five tenets of Army operations doctrine

Doctrine enables the combat force to take advantage of opportunities to achieve tactical or operational success. Ammunition units must follow the five logistics characteristics, as presented in [FM 100-5](#) (see Figure 1-2), to support combined arms operations.

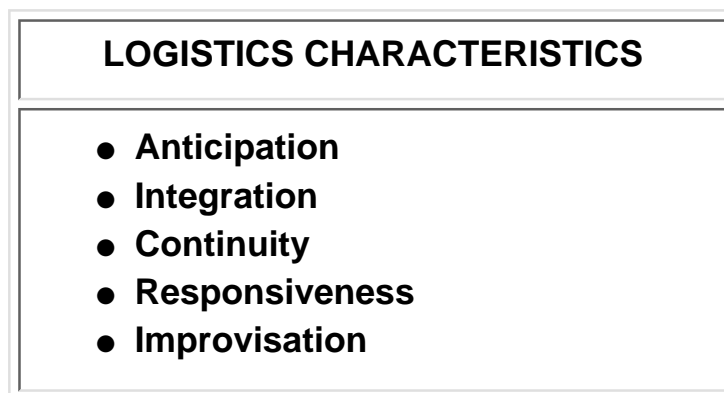

Figure 1-2. Five logistics characteristics

#### Anticipation

Combat service support (CSS) commanders must *anticipate* future events and the needs of combat commanders. Staffs must devise and develop new methods for supporting those needs. While the unit is still supporting current operations, the logistics planner must forecast munitions demands based on future operations plans. Logistics planners must anticipate events and still remain flexible enough to accommodate likely contingencies. Successful anticipation in munitions support operations is the ability to meet shifting demands resulting from rapidly changing tactical conditions. To best support combat units, it is imperative that logistics officers be tactically and technically competent. See [FM 100-5](#), Chapter 3, for a more detailed explanation of this characteristic.

#### Integration

Unity of effort requires that CSS commanders fully *integrate* logistical support into the tactical and operational plans of the combat commanders. Munitions support must be bold, innovative, and based on a clear understanding of the commander's intent; however, guidelines for safe, secure operations must be followed. Combat commanders require the greatest possible freedom of action; therefore, munitions units must organize to support the combat forces and their operations. Also, munitions support must be fully integrated into deception plans.

#### Continuity

*Continuity* in munitions support is a critical factor in allowing combat commanders to have depth, retain momentum, and maintain the initiative. The *continuity* of sustainment is paramount to the continued success of the operation. While the tempo of combat operations varies, sustainment operations never cease. During lulls in combat, munitions units must rebuild combat loads and replenish stocks. Also, they must conduct inspections, preventive maintenance services, repacking, demilitarization, destruction, and retrograde operations.

#### Responsiveness

All munitions support units must be *responsive* to the changing needs of the combat user. They must be



prepared to relocate their support base and redirect incoming munitions without interrupting the flow of ammunition to the fighting force. CSS plans must be flexible to allow the combat commander the ability to fully exploit a tactical opportunity.

### Improvisation

**Improvisation** is the ability that allows the commander to react to unexpected and unanticipated events and to exploit them to the fullest to accomplish his mission. No amount of planning can account for all possible contingencies on the battlefield. When the normal supply of ammunition is interrupted, extraordinary effort, innovative supply procedures, and other unconventional methods may be needed to support combat operations. However, improvisation is not the answer for poor prior planning on the part of the commander.

### PLANNING GUIDANCE

The CSS commander should use the four support considerations (see Figure 1-3) as a guide when incorporating combat service support sustainment into operational plans.

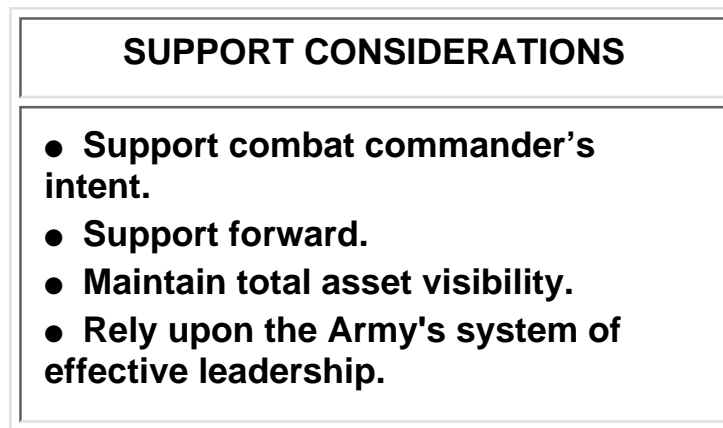

**Figure 1-3. Four support considerations**

The first consideration is *supporting the combat commander's intent*. The commander's intent may change with the situation and depends on many variables.

The second is *supporting as far forward as possible*. As ammunition containers arrive in theater, they are sent forward to a TSA or CSA. At the CSA the containers are unloaded, and the ammunition is configured into mission configured loads (MCLs). The MCLs are then sent forward to ASPs or ATPs.

The third is *maintaining total asset visibility* (TAV) to meet the needs of the combat forces. TAV means that munitions supplies are tracked from the time that they are introduced into the distribution pipeline until they arrive at their final destination so that their exact location is known at all times.

The fourth is *relying upon the Army's system of effective leadership* to adapt to the changing needs of the battlefield. Effective leadership enables ammunition unit commanders to accomplish their critical munitions support mission to the combat forces. All commissioned officers, warrant officers, and noncommissioned officers must be effective leaders as well as technically and tactically proficient.

### MUNITIONS STRATEGIC, OPERATIONAL, AND TACTICAL LOGISTIC LEVELS

Levels of munitions support parallel the strategic, operational, and tactical levels of war (see Figure 1-4). At the strategic level, the national military strategy determines the theater strategy. The theater campaign plan is derived from the theater strategy and links the operational level (joint task force [JTF] campaign plans) to the strategic level (theater strategy). Plans for conducting major operations are derived from the JTF campaign

plan. Battles and engagements are the tactical level components of major operations. Ammunition support is an integral part of the plan at each of these levels.

Munitions support is instrumental to the commander in building, sustaining, and projecting combat power to shape the battle. It is an essential part of the logistics system at each level of war. The theater (operational level) munitions system links the strategic and tactical levels of war. For more information, see [FMs 100-5](#), [100-10](#), and [100-16](#).

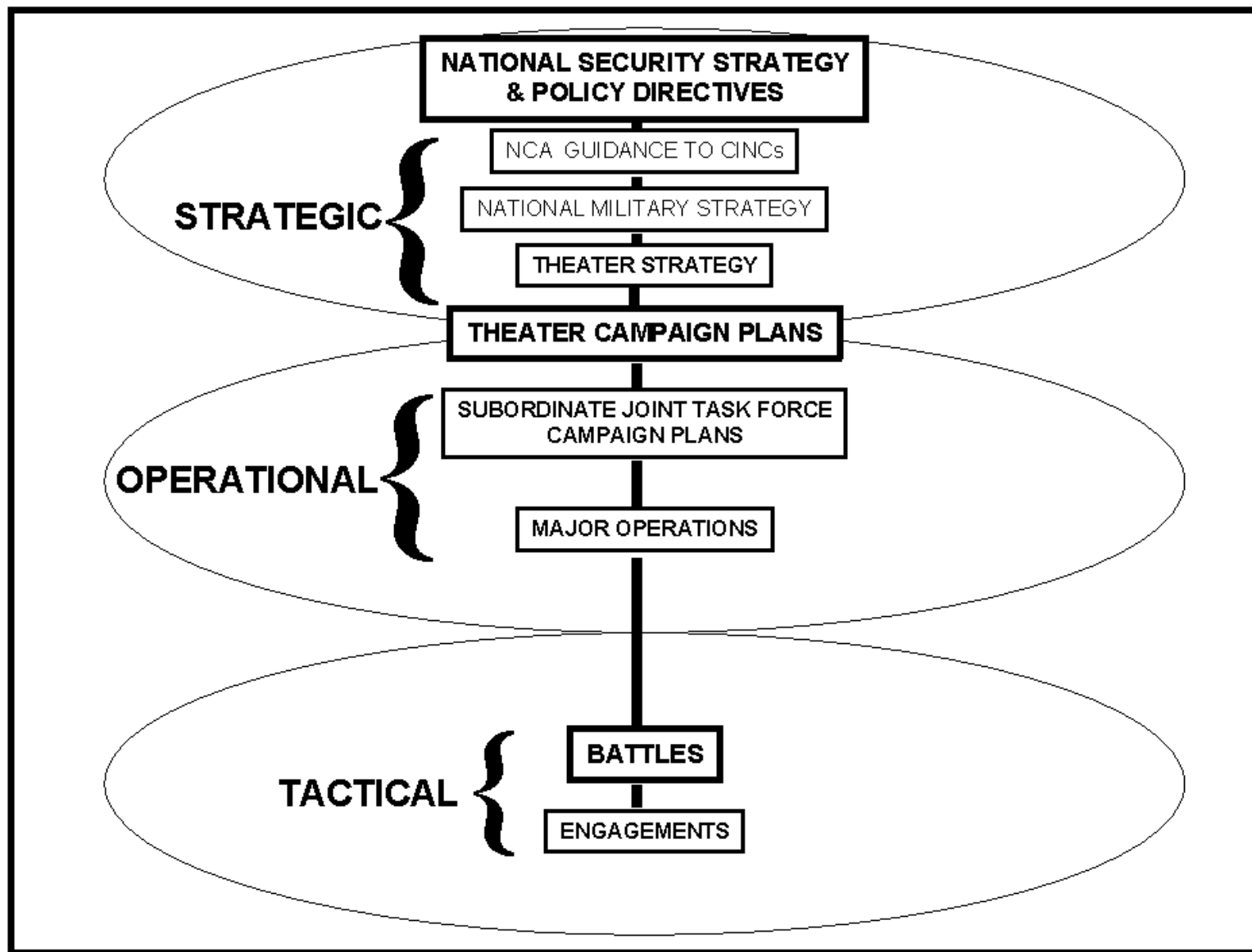

Figure 1-4. Levels of war and guidance hierarchy

### Strategic Level of Munitions Logistics

The strategic level of the munitions logistic system is the support base for all deployed forces and provides munitions based upon projected munitions expenditures. The strategic munitions logistic system includes special activities under Department of the Army (DA) control. These include national inventory control points (NICPs), national maintenance points, depots, arsenals, plants, and factories. Supporting the strategic level of munitions is the function of these CONUS organizations or the theater base in the COMMZ and is coordinated with the logistics support element (LSE).

The LSE is the forward element of the munitions logistical base. It provides limited strategic level or other directed logistics support in the theater on an interim basis. The Army service component commander (ASCC) (formerly known as the theater commander) has command and control of the LSE.

An LSE consists of military, contractors, and civilian employees. They provide support within, as well as outside, the theater of operations, producing a seamless system. To optimize the logistics flow, the munitions logistics system is centrally managed at the strategic level and decentralized at the operational and tactical levels.

The United States Army Materiel Command (USAMC) coordinates strategic organization actions through the LSE deployed in the theater. The early deployment of the LSE ensures a positive link to deploying ammunition units. Also, the LSE may have to fill gaps in the munitions support force infrastructure until the deploying units arrive in theater. The initial deployment will be for logistical assistance along with the other logistics personnel assigned to major units. The LSE does not replace capabilities provided by munitions support units in the force structure. Rather, it provides an interface between the strategic and operational munitions logistics levels.

### **Operational Level of Munitions Logistics**

The ASCC links Army plans to the combat commander's strategic level plans. The Army forces (ARFOR) commander links his plans to the operational level plans. These links enable the operational level of munitions logistics to support the commander in chief's (CINC's) plan. See [FM 100-7](#) for more information.

Providing this support in a force projection environment presents new challenges. The ARFOR commander establishes priorities for operational level munitions. Operational bases within a theater provide strategic and operational munitions support to the tactical forces. Based on METT-T, the CINC develops a munitions organization capable of executing munitions CSS tasks to support the campaign plan.

The difference between the operational and tactical levels of munitions logistics is the longer planning and preparation time required to support extended operations. The operational level of munitions logistics encompasses support required to sustain campaign plans and major operations. It attempts to balance current consumption of munitions supplies with the needs of future major operations. It also enables success at the tactical level of war.

Operational munitions support significantly impacts the ARFOR commander's decision process. The commander uses METT-T to determine logistics time and distance factors, throughput, and lines of communication (LOCs). Assured logistics communications supporting high data transmission rates with the national industrial base provide TAV of critical items. In-transit visibility (ITV) allows the commander to know the location of resources in transit and to allocate them based on their projected arrival. The operational level of the munitions logistic system provides the link between the strategic and tactical levels.

### **Tactical Level of Munitions Logistics**

The tactical level of munitions logistics sustains the tactical commander's ability to fight battles and engagements. Successful tactical level munitions logistics provide the right munitions, on time, at the correct location to the requesting unit. Mobile, responsive capabilities are essential for preparation and execution of the tactical level of munitions logistics.

The munitions distribution system includes all supply activities needed to provide munitions to the using units within a theater of operations. Munitions requirements from combat battalions and brigades proceed through

the materiel management channels of the divisions, corps, and theater until they ultimately reach the CONUS-based NICP.

The use, and therefore the structure, of ASAs have evolved. ASAs vary in size, capability, and mission. They are not bound by strict, hierarchical support structures but are based on projected mission requirements.

### **SUPPORT STRUCTURES**

Munitions support units are organized to meet mission support requirements. Each unit has the appropriate mix of personnel, MOS skills, tools, and equipment to accomplish assigned missions. Chapter 2 of this manual provides more information on the structure of munitions support units and doctrine.

---

---

## **CHAPTER 2**

### **MUNITIONS SUPPORT STRUCTURE**

#### **PURPOSE AND SCOPE**

This chapter describes the munitions support structure and distribution system. Topics include the two types of munitions support units: MOADS-PLS units and modular ammunition units. Also discussed is the flow of munitions, information, and documents, as well as the responsibilities of distribution managers at each echelon.

#### **AMMUNITION SURGE SUPPORT**

Major operations and deployments create a tremendous demand on CONUS ammunition depots and port facilities. The Army no longer has massive stockpiles of munitions outside CONUS (OCONUS), and the amount of Army prepositioned stocks (APS) are limited. This leaves stateside depots and ports to provide most of the munitions required in an operation. Very early in the deployment process, planners must provide augmentation support to these depot and port facilities. A significant number of the Army's munitions units are in the Reserve Components (RC). For that reason, RC units should assist in the planning process. Also, RC munitions units will probably assist in providing both planning and surge support.

When planning to use RC units to provide surge support, planners must consider the time required to mobilize and deploy the units. It usually takes an RC unit at least two weeks to complete the mobilization process. This time must be factored into all operational plans.

When the modular ammunition unit concept is implemented, one or more medium or heavy lift platoons may be assigned to each depot and port requiring augmentation. The number assigned will depend on several factors:

- Projected size and duration of the operation.
- Projected amount of munitions to be shipped.
- Size of the depot or port and the facilities, equipment, and personnel organic to the depot or port.
- Readiness level of augmentee units.

Providing surge support to CONUS depots and ports is critical to the success of any operation. Ammunition sitting in state-side storage facilities does not win battles; the failure to get it to the theater of operations may result in unnecessary casualties and an unsuccessful operation.

#### **SUPPORT STRUCTURE OVERVIEW**

The mission of the munitions support structure is to deliver the required type and amount of munitions to the combat user at the time and location it is needed. This requires an efficient, effective, and flexible munitions distribution system. To meet the needs of combat commanders, the munitions distribution system must adhere to the sustainment imperatives presented in [FM 100-10](#) and Chapter 1 of this manual.

#### **AMMUNITION SUPPORT ACTIVITIES**

Three types of ASAs are in the theater: TSAs, CSAs, and ASPs. An ammunition transfer point (ATP) is not considered an ASA because of its temporary nature.

The ASA mission is to receive, store, issue, and maintain the theater's conventional ammunition stocks. Also, ASAs configure ammunition into MCLs. Once configured, MCLs are shipped forward to ATPs for issue to combat units.

#### **Theater Storage Area Operations**

The TSA encompasses the storage facilities located in the COMMZ. This is where the bulk of the theater reserve ammunition

stocks is located. TSAs are operated and maintained by one or more general support (GS) ammunition companies, or by one or more medium or heavy lift modular ammunition platoons. Besides shipping ammunition to CSAs, the TSA provides area ammunition support to units operating in the COMMZ.

A TSA receives most of its ammunition in International Standardization Organization (ISO) containers. The unit operating the TSA must have the capability to move containers on and off railcars and line-haul transporters. To facilitate shipment, TSAs must be located where there is easy access to highways, railroads, airheads, and ports (see Figure 2-1). When a TSA's wartime stockage objective exceeds 25,000 short tons (ST), a second TSA should be established.

The TSA stockage objective is determined by the ASCC. [AR 710-2](#) contains basic days of supply (DOS) policy for Class V. The theater army area command (TAACOM) ammunition group must keep the operational level materiel management center (MMC) informed of storage limitations or shortages in each TSA.

### Corps Storage Area Operations

The CSA is the primary source of high-tonnage ammunition for the division and corps. It is operated by one or more GS ammunition companies or one or more medium or heavy lift modular ammunition platoons. The number of units assigned to operate a CSA depends on the corps authorized ammunition stockage level. CSAs receive 50 percent of their ammunition from the port of debarkation (POD) and 50 percent from the TSA. At a minimum, each corps will identify an ASA to meet these requirements.

CSAs provide 100 percent of the ASP's ammunition and 75 percent of the ATP's ammunition, configured as MCLs. Besides providing ammunition to ASPs and ATPs, CSAs provide area ammunition support to units operating in the corps rear.

One CSA is normally required to support ASP and ATP operations for each committed division. Stockage objectives for the CSA are established by the corps support command (COSCOM) and are based on projected theater combat rates. Initially, the stockage objective of a CSA should be 10-15 days of supply. After the initial combat drawdown, the CSA should maintain 7-10 days of supply. When a CSA's wartime stockage objective exceeds 25,000 ST, a second CSA should be established.

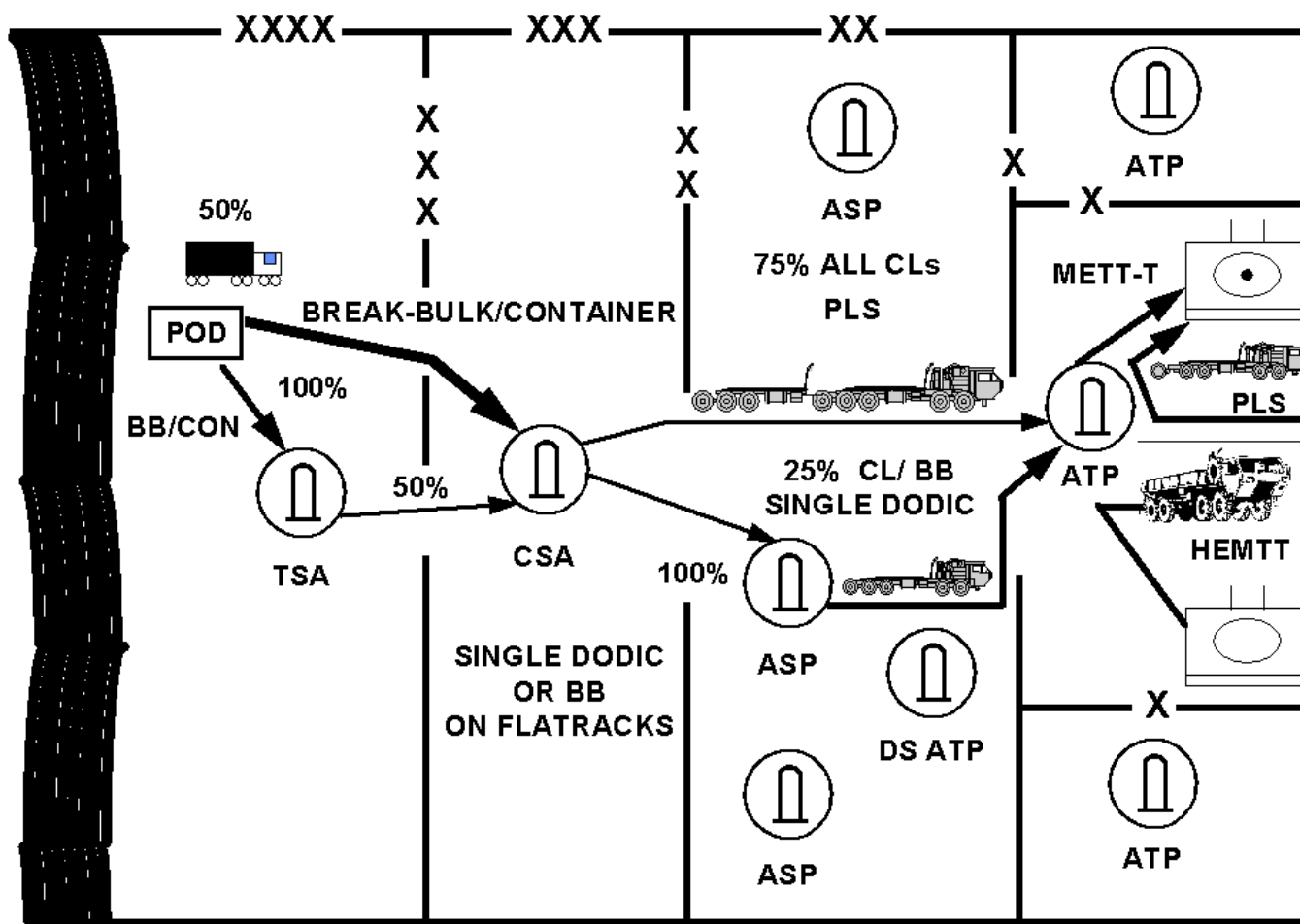

### Figure 2-1. Flow of munitions in a theater of operations

The COSCOM ammunition battalion analyzes workload requirements based on the forecast and resupply requirements provided by the division ammunition officer (DAO). From this requirements analysis, the battalion determines how to best provide ammunition resupply to the combat units it supports.

The ammunition battalion must synchronize ASA operations with corps transportation assets to ensure the timely movement of ammunition stocks. With the incorporation of modular units, the number of medium lift and heavy lift platoons will be based on workload. At a minimum, one MLP will be required at each CSA to meet MCL workload.

#### Ammunition Supply Point Operations

ASPs are another source of ammunition for the division. ASPs receive, store, issue, and maintain a one- to three-day supply of ammunition. ASP stockage levels are based on tactical plans, availability of ammunition, and the threat to the resupply operation.

ASPs are located in the division rear. Normally, three MLPs are required to support a division and to provide manning for the division rear ATP. An ASP is normally operated by a direct support (DS) ammunition company or one or more medium lift modular ammunition platoons. (A DS ammunition company can operate up to three ASPs plus an ATP.) If the ASP must handle containerized ammunition, based on METT-T, HLPs must be assigned to the ASP. Depending on METT-T, engineer support may be required to establish and maintain the ASP. During the ASP site selection process, commanders should focus on locations that minimize the need for engineer support. Possibilities include villages, commercial buildings, or farm complexes.

ASPs provide 25 percent of each ATP's ammunition requirement in the form of MCLs. Besides supporting ATPs, ASPs provide ammunition to units operating in the division rear area. These nondivisional and corps units normally receive support from the closest ASA.

#### Ammunition Transfer Point Operations

ATPs are the most mobile and responsive of the munitions supply activities. CSAs and ASPs deliver ammunition to the ATP using corps transportation assets. This ammunition is kept loaded on semitrailers or PLS flatracks until ATP personnel transload it to using unit vehicles. If the situation demands, the ammunition can be transferred immediately to using unit tactical vehicles.

ATPs receive about 75 percent of their ammunition as throughput from the CSA. The other 25 percent comes from an ASP and is in the form of MCLs.

ATPs are located in each brigade support area (BSA) with an additional one in the division support area (DSA). The mission of each ATP is to provide 100 percent of the ammunition required by all infantry, armor, artillery, combat aviation, combat engineer, and air defense units in its sector. This includes divisional and non-divisional units (i.e., corps artillery) operating in the brigade area. A DAO noncommissioned officer (NCO) is located at each ATP to control the issue of munitions.

The corps DS ammunition company operates the ATP in the DSA. This ATP supports all corps, divisional, and nondivisional units in the DSA. It receives mission guidance and responds to the priorities established by the DAO.

Each maneuver brigade has a forward support battalion (FSB) that operates an ATP. ATPs are operated by the ammunition section of the supply company in the FSB. These ATPs provide ammunition support to all units in the brigade support sector and receive mission guidance from the DAO.

The FSB support operations officer, in conjunction with the DAO NCO representative, coordinates directly with nonorganic units supported by the ATP. Their munitions requirements are consolidated by the support operations officer/DAO, and their request for resupply consolidated with the brigade request. The DAO/movement control battalion (MCB) and the FSB support operations officer coordinate the location, amount, and type of munitions (MCLs) to be received at the ATP. Munitions are delivered by corps transportation assets. ATP personnel interrogate radio frequency (RF) tags of arriving PLS shipments to gain immediate visibility of the shipment and to identify the organization to which it will be issued.

Units arriving at the ATP to pick up munitions drop off empty, or partially empty, PLS flatracks and retrieve fully loaded flatracks. ATP personnel assist units without the PLS to transload munitions. Uploaded flatracks are normally issued in the same configuration as received.

All empty flatracks are shipped back to the nearest ASP, CSA, or TSA as soon as possible. All issues and turn-ins are reported by the DAO representative. The unit ammunition turn-ins are picked up for immediate retrograde by corps transportation assets used

to deliver ammunition resupply. A DAO representative attaches RF tags to retrograde shipments. The movement tracking system (MTS) tracks ammunition returns as they are retrograded. The MTS also allows shipments to be redirected if necessary.

### **AMMUNITION UNITS**

The ammunition force structure is evolving. In the near future, and well into the twenty-first century, ammunition units will continue to become smaller and more flexible and capable of deploying more rapidly.

#### **Headquarters and Headquarters Company, Ordnance Group (Ammunition) (DS/GS)**

The mission of the headquarters and headquarters company (HHC), ordnance group (ammunition), is to command and control assigned or attached DS and GS ammunition units (see Figure 2-2, page 2-6). The ordnance group is primarily responsible for the ordnance support structure for ordnance units assigned to echelons above corps (EAC). It is responsible for TSA operations. Also, the ordnance group commands, controls, and plans ammunition missions, to include the following:

- Retrograde activities.
- Enemy ammunition inspection, processing, and shipping.
- Operating ASAs for COMMZ transient units.
- Advising ASCC on theaterwide ammunition policy.
- Establishing ammunition supply and maintenance procedures consistent with the policies and directives of the ASCC and the corps.

The ordnance group executes missions through subordinate ordnance battalions or in coordination with area support groups (ASGs). The ordnance group provides technical assistance through the materiel section to ASG ordnance planners. Also, the group can provide coordination for resolving support problems between subordinate units, supported units, and CONUS depots.

Ordnance group technical assets can be deployed before, during, and after operations to work in concert with the taacom, the LSE, and the theater army materiel management center (TAMMC).

The ordnance group (ammunition) is assigned to a TAACOM. It is allocated one per theater or one per two to six battalions commanded. At 100 percent of assigned personnel, ammunition group missions include the following:

- Command, control, and staff planning for up to six subordinate units.
- Technical direction of subordinate unit ammunition support operations, except for inventory management functions for which the TAACOM MMC is responsible.



## Headquarters and Headquarters Company Ordnance Group, Ammunition

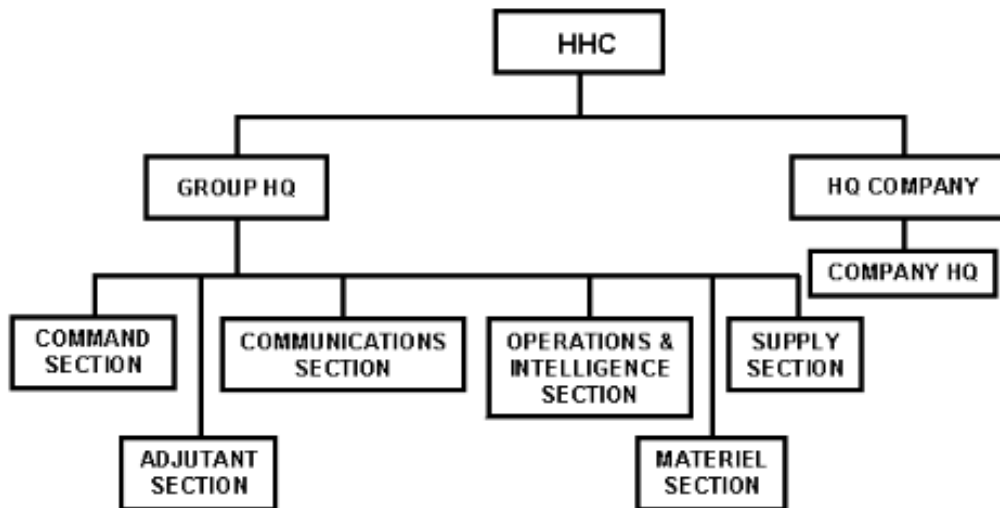

**Mission:** Command and control assigned or attached, DS and GS ammunition units or other attached units.

**Assignment:** Assigned to a TAACOM.

**Capabilities:** At 100 percent of assigned personnel, this unit can provide:

- Command, control, and staff planning for up to six subordinate units.
- Technical direction over ammunition support missions of subordinate units, except for inventory management functions for which the operational level MMC is responsible.

**Basis of Allocation:** Normally one per TAACOM or one per two to six battalions commanded.

**Mobility:** This unit is required to move 50 percent of its TOE equipment and personnel in a single lift, using organic vehicles.

**Figure 2-2. Ordnance group, ammunition (DS/GS) ([TOE 09662L000](#))**

### Headquarters and Headquarters Detachment, Ordnance Battalion (Ammunition) (DS/GS)

The mission of the headquarters and headquarters detachment (HHD), ordnance battalion (ammunition) (TOE 09466L000 or [TOE 09666L000](#)), is to command and control assigned units or attached DS and GS ammunition units or other attached units (see Figure 2-3 and Figure 2-4). These units ensure compliance with ammunition supply and maintenance procedures established by the TAACOM.

This unit is assigned to a COSCOM or a corps support group (CSG). It may also be assigned to a TAACOM, normally attached to an HHC, conventional ammunition group (DS/GS). A minimum of one ammunition battalion is required per COSCOM to support a fully deployed corps. This battalion is allocated one per three to five companies commanded. It can provide:

- Command, control, and staff planning for up to five subordinate units.
- Technical direction over ammunition support operations of subordinate units. The exception is inventory management functions, for which the operational level MMC is responsible.

### MOADS-PLS Units

The structure of ammunition units and the munitions support concept are revised as combat doctrine evolves.

Under MOADS, a large number of troops were deployed OCONUS to maintain and distribute the vast stockpiles of munitions stored in overseas depots. The MOADS system was designed for break-bulk resupply and multiple transfers of munitions.

The conversion of units to MOADS-PLS has resulted in the more rapid movement of supplies and less frequent transfers through the use of MCLs. Other results under MOADS-PLS include the requirement for fewer soldiers and less equipment. Also, this system provides limited ammunition unit flexibility and ITV of munitions stocks. Table 2-1 shows the lift capability and manpower requirement for each type of materials handling equipment (MHE) listed.

**General Support (GS) Ammunition Companies (MOADS-PLS).** General support companies, which are organized under [TOE 09433L000](#) and TOE 09633L000, establish a CSA/TSA in the COMMZ and corps rear area and behind each committed division. Also, one or more GS ammunition companies will establish a CSA or TSA. Allocation of these companies is based on theater stockage objectives and supported force requirements.

The CSAs provide munitions support throughout the corps and serve as the primary source of high-tonnage munitions for the division. Figure 2-5 and Figure 2-6 illustrate the structure of GS MOADS-PLS units.

**Direct Support (DS) Ammunition Companies (MOADS-PLS).** Direct support companies, which are organized under [TOE 09484L000](#), establish three ASPs and a rear ATP to support divisional and nondivisional units in the division area. One DS company is allocated per division. Figure 2-7, page 2-12, illustrates the structure of DS MOADS-PLS units.

### Headquarters and Headquarters Detachment Ordnance Battalion, Ammunition, DS/GS

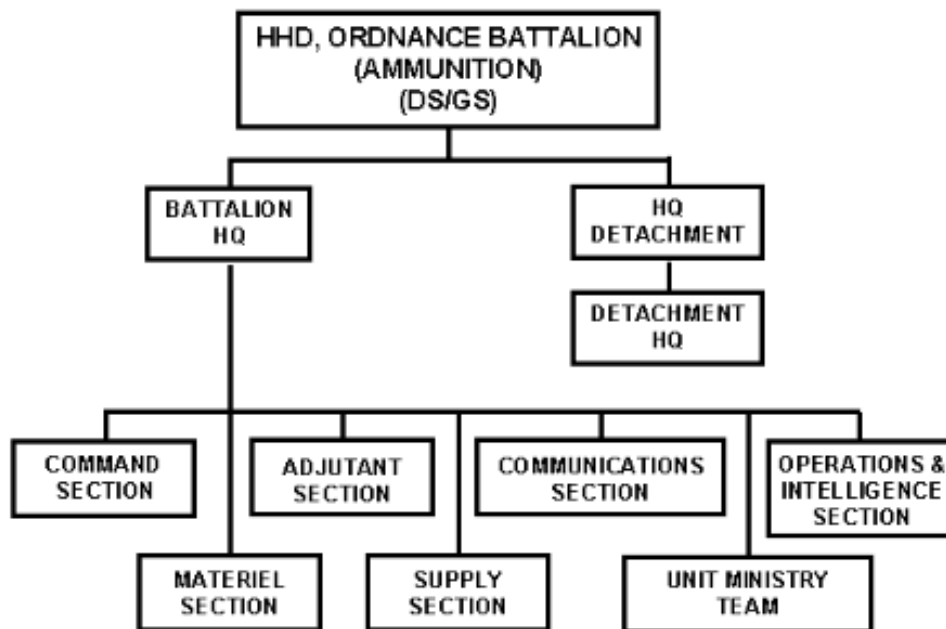

**Mission:** Command and control of assigned or attached companies or modular ammunition platoons or other attached units.

**Assignment:** Assigned to a CSG.

**Capabilities:** At 100 percent of assigned personnel, this unit can provide:

- Command, control, and staff planning for two to five subordinate units.
- Technical direction over ammunition support missions of subordinate units, except for inventory management functions for which the operational level MMC is responsible.

**Basis of Allocation:** Normally one per two to five companies commanded.

**Mobility:** This unit is required to move 50 percent of its TOE equipment and personnel in a single lift, using organic vehicles.

Figure 2-3. Ordnance battalion, ammunition (DS/GS) (TOE 09466L000)

### Headquarters and Headquarters Detachment Ordnance Battalion, Ammunition, DS/GS

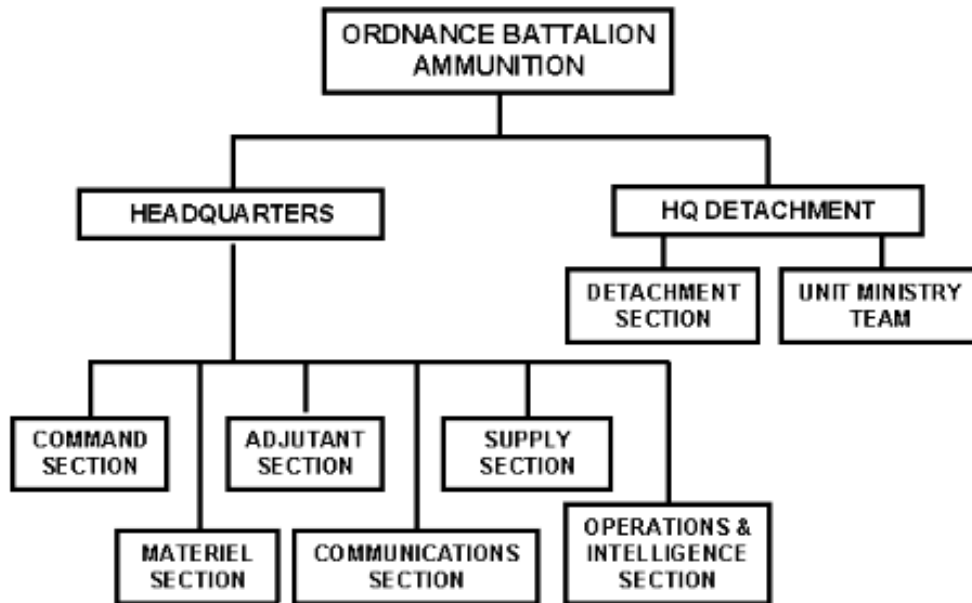

**Mission:** Command and control assigned or attached, ammunition companies or modular ammunition platoons or other attached units.

**Assignment:** Assigned to a TAACOM or ordnance ammunition group.

**Capabilities:** At 100 percent of assigned personnel, this unit can provide:

- Command, control, and staff planning for two to five subordinate units.
- Technical direction over ammunition support missions of subordinate units, except for inventory management functions for which the operational level MMC is responsible.

**Basis of Allocation:** Normally one per two to five companies commanded.

**Mobility:** This unit is required to move 50 percent of its TOE equipment and personnel in a single lift, using organic vehicles.

Figure 2-4. Ordnance battalion, ammunition (DS/GS) ([TOE 09666L000](#))

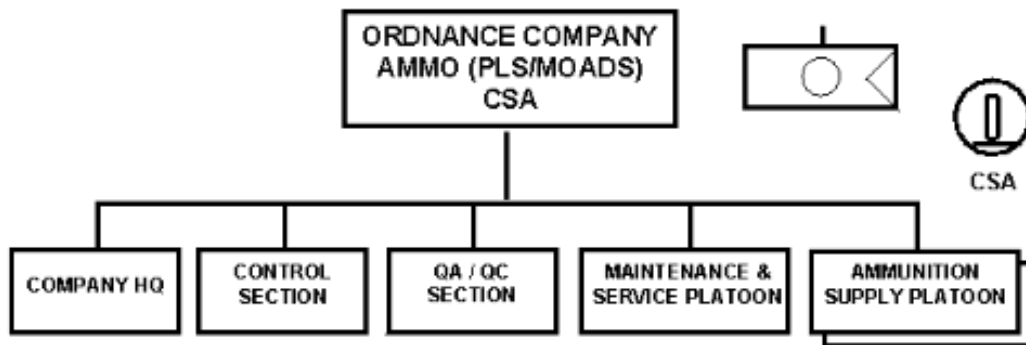

**Mission:** Establishes and operates an ammunition supply facility engaged in receiving, storing, rewarehousing, combat configuring, and issuing conventional ammunition using the PLS.

**Capabilities:** At level 1, this unit (objective TOE) has a daily capability to receive 1,750 STONs palletized break-bulk ammunition on theater semitrailers from the port and 1,750 STONs palletized break-bulk ammunition PLS racks uploaded on theater semitrailers from the TSA. The unit configures and issues up to 3,500 STONs of ammunition loaded on PLS racks for a total of 7,000 STONs per day.

**Assignment:** To rear CSGs; ordnance battalion, ammunition, DS/GS, TOE 09466L000.

**Basis of Allocation:** One company per every 7,000 STONs of ammunition received, stored, issued, and configured.

**Mobility:** Unit is 50 percent mobile, less ammunition stocks.

**References:** FM 54-30  
FM 63-3

Figure 2-5. Ordnance company, ammunition (MOADS-PLS) (CSA) (SRC 09433L000)

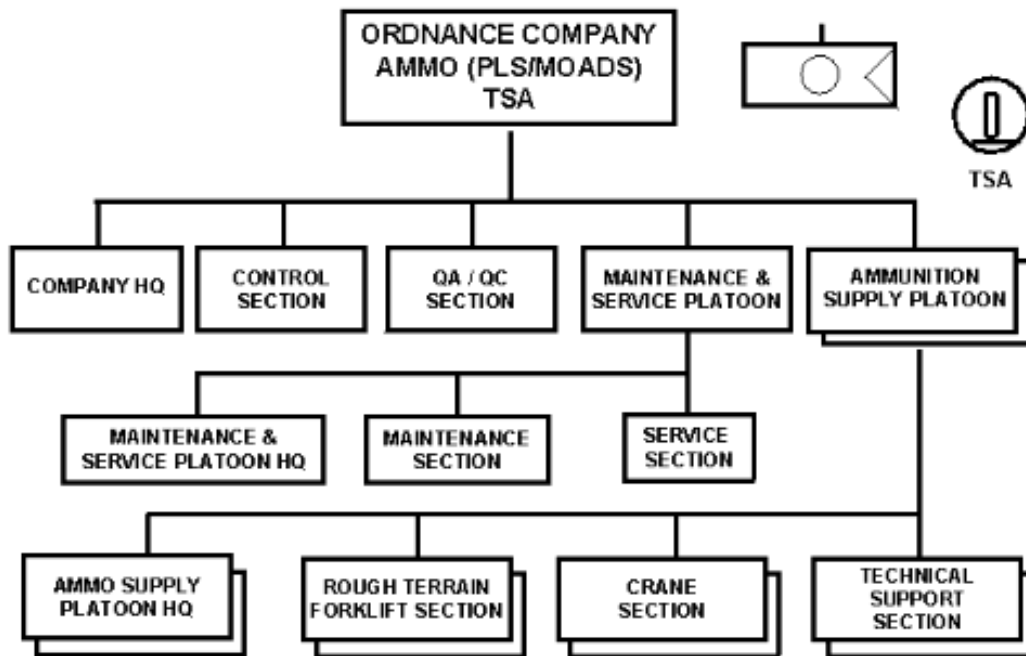

**Mission:** Establishes and operates an ammunition supply facility engaged in the receipt, storage, rewarehousing, container unstuffing, and issue of conventional ammunition using the PLS.

**Capabilities:** At level 1, this unit (objective TOE) has a daily capability to receive 2,333 STONs containerized/palletized break-bulk ammunition on theater semitrailers from the port and 2,333 STONs containerized/palletized break-bulk ammunition PLS racks uploaded on theater semitrailers from the port. The unit unstuffs containers and issues up to 3,500 STONs of ammunition on PLS racks for a total of 7,000 STONs per day.

**Assignment:** To TAACOM ammunition group, ordnance battalion, ammunition, DS/GS, TOE 09666L000.

**Basis of Allocation:** One company per every 7,000 STONs of ammunition received, stored, issued, and configured.

**Mobility:** Unit is 50 percent mobile, less ammunition stocks.

**References:** FM 63-4

Figure 2-6. Ordnance company, ammunition (MOADS/PLS) (TSA) (SRC 09633L000)

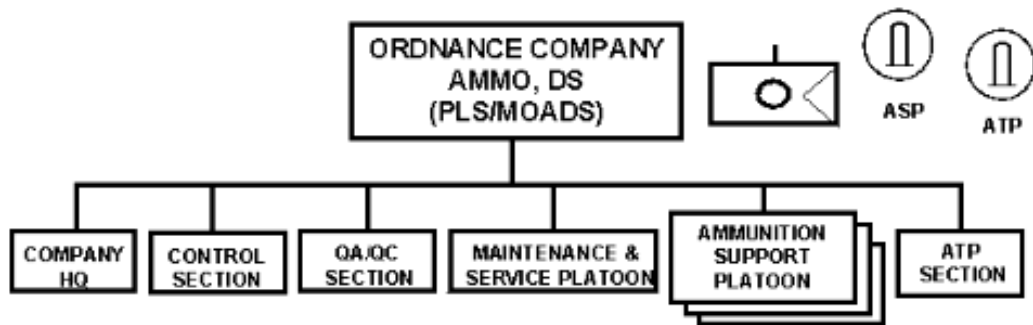

**Mission:** Establishes and operates three geographically dispersed ASPs and an ATP engaged in receiving, storing, rewarehousing, combat-configuring, and issuing conventional ammunition using the PLS.

**Capabilities:** At level 1, this unit (objective TOE) provides the following lift capability: ASP, 2,530 STONs; and ATP, 970 STONs. Lift is normally divided between receipt, issue, configuration into MCLs, and storage.

**Basis of Allocation/Employment:** One per division; assigned to a COSCOM, attached to a CSB in a CSG.

**Mobility:** Unit is 50-percent mobile, less ammunition stocks.

**References:** FM 54-30  
FM 63-3

Figure 2-7. Ordnance company, ammunition (DS) (MOADS-PLS) (SRC 09484L000)

Table 2-1. MAN/MHE team lift capabilities by STONs per day

MHE	GS (TSA/CSA)	DS (ASP)	ATP
6,000-lb variable-reach forklift	187	119	88
4,000-lb rough-terrain forklift	126	58	NA
7 1/2-ton rough-terrain crane	NA	219	NA
65-ton container crane	295	NA	NA
6,000-lb rough-terrain forklift	165	74	75
10,000-lb rough-terrain forklift	116	52	NA
5-ton rough-terrain crane	NA	200	NA
20-ton rough-terrain crane	257	NA	NA

**\* When being operated, all forklift man/MHE teams require two persons per forklift plus a ground assistant. Crane men/MHE teams require three persons per crane-an operator and two ground assistant operators. Ground assistants are for safety purposes; any personnel in the area may perform this task.**

### **Modular Ammunition Units**

With the end of the cold war, the Army began to evolve from a forward-deployed force to a primarily CONUS-based force capable of projecting combat power to any part of the world and to any type of theater.

The MOADS doctrine and force structure were designed to support a forward-deployed force. Conversely, the wide variety of possible missions facing the CONUS-based force projection Army requires an ammunition distribution system capable of supporting any contingency. This more flexible distribution system is based on the concept of modularity.

Under the modularity concept, only the number of soldiers or amount of equipment needed to support the forces are deployed. This might mean deploying a single platoon to support a brigade contingency or a company with added platoons attached to support a mature theater.

The initial deployment of modular ammunition units to a theater will consist of one or more platoons. Heavy lift modular platoons are capable of loading, moving, and unloading 20-foot ISO containers. The MLP has no container handling capabilities.

As the theater matures and more modular ammunition units arrive in theater, a conventional command and control structure is established, and the modular platoons are formed into company-sized units. Table 2-2 illustrates modular ammunition platoon lift capacities.

**Table 2-2. Modular ammunition platoon  
lift capabilities**

<b>HEAVY LIFT PLATOON</b>	
<b>MISSION</b>	<b>LIFT CAPACITY</b>
<b>RECEIVE</b>	<b>886 ST</b>
<b>REWAREHOUSE/RECONFIGURE</b>	<b>886 ST</b>
<b>ISSUE</b>	<b>886 ST</b>
<b>TOTAL LIFT CAPABILITY</b>	<b>2,658 ST</b>
<b>MEDIUM LIFT PLATOON</b>	
<b>MISSION</b>	<b>LIFT CAPACITY</b>
<b>RECEIVE</b>	<b>376 ST</b>
<b>REWAREHOUSE/RECONFIGURE</b>	<b>376 ST</b>
<b>ISSUE</b>	<b>376 ST</b>
<b>ATP</b>	<b>393 ST</b>
<b>TOTAL LIFT CAPABILITY:</b>	<b>1,521 ST**</b>

<b>MAXIMUM STORAGE PER PLATOON</b>	
<b>HEAVY LIFT PLATOON</b>	<b>7,100 ST***</b>
<b>MEDIUM LIFT PLATOON</b>	<b>7,046 ST***</b>
<p><b>* Short tons (ST) per day.</b></p> <p><b>** When operating in a CSA or TSA with no ATP mission, the MLP has a total lift capability of 1,521 ST (507 ST per mission). When the ATP section of the MLP is employed separately, it has a lift capability of 393 ST/day. Each MLP can provide one-third a rear ATP. The figures are based on 24-hour operations.</b></p> <p><b>*** This capacity represents a portion of the designated level of the theater stockage objective.</b></p>	

A modular ammunition company consists of a company headquarters platoon and from two to five heavy and/or medium lift platoons. The headquarters platoon (Figure 2-8, page 2-15) is capable of commanding and controlling multiple geo-graphically separated platoons as METT-T requires. However, the headquarters platoon must be collocated with at least one of these platoons for logistical support. This headquarters is capable of consolidating platoons in the COMMZ and providing support to corps and division areas.

The ammunition platoon (heavy lift) (Figure 2-9) is capable of supporting units on an area basis through receipt, storage, stock management, inventory control, and issue. Also, this platoon is capable of loading or off-loading 20-foot ISO containers from inbound or outbound transportation assets. It employs PLS vehicles to move stocks, rewarehouse, move configured loads to a holding area, and move organic equipment. The prepositioned munitions ships will have a portion of the unit's equipment aboard. Therefore, at least one of these platoons must arrive in theater at the same time or before the prepositioned ships. A platoon can operate independently from an ammunition company headquarters, but needs outside support for sustainment. It is 100 percent mobile, less ammunition stocks.

The ammunition platoon (medium lift) (Figure 2-10) does not have container-handling equipment. This platoon can unstuff a 20-foot ISO container, if necessary, to mission configure break-bulk munitions. The ammunition platoon is capable of receipt, storage, stock management, inventory control, mission-configuring, and issuing to supported units on an area basis. The ammunition platoon can operate independently from an ammunition company headquarters, but it requires outside support for sustainment. It is 100 percent mobile, less ammunition stocks on hand, and has PLS vehicles to enable the rapid movement of ammunition within the ASA.



**Modular Ammunition Company  
Company Headquarters  
SRC 09408L000**

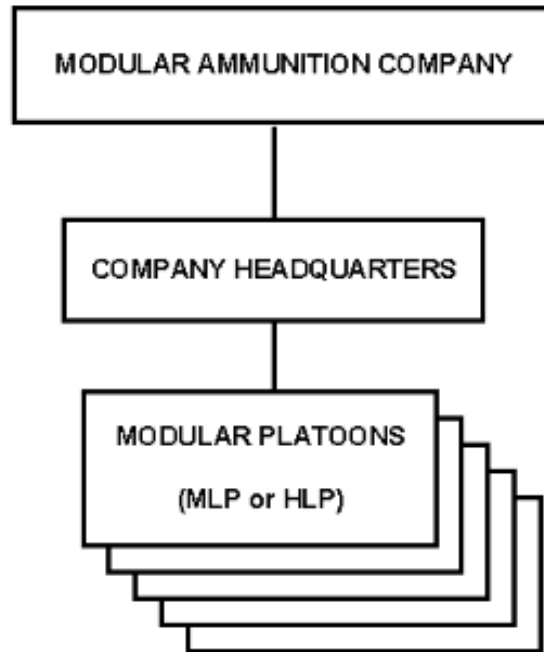

**Mission:** Provides command, control, administrative, planning, and logistical support for two to five modular ammunition platoons.

**Assignment:** Depends on assigned mission.

When assigned the ASP function, the unit is assigned to a CSB (TOE 63426L000).

When assigned the CSA function, the unit is assigned to a CSB (TOE 63426L000) or a corps ammunition battalion (TOE 09666L000).

When assigned the TSA function, the unit is assigned to an ammunition battalion (EAC) TOE 09666L000.

**Basis of Allocation:** As required by theater operations and the number of modular ammunition platoons deployed.

**Mobility:** The company headquarters is 100 percent mobile.

**Figure 2-8. Modular ammunition company headquarters platoon**

**Modular Ammunition Platoon  
Heavy Lift (HLP)  
SRC 09503LB00**

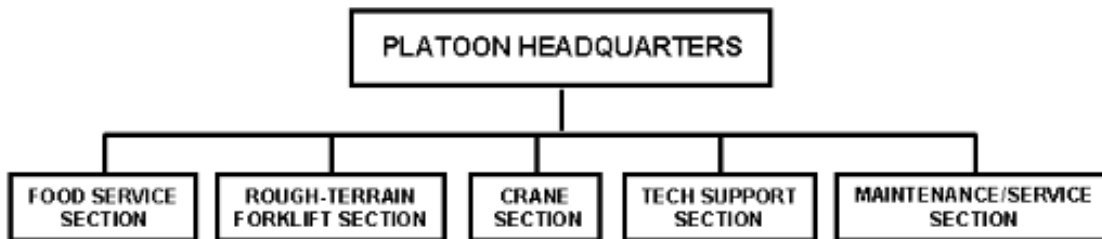

**Mission:** Receives and ships containerized ammunition. Configures, inspects, issues, manages, ships, and retrogrades ammunition stocks. Operates independently or as part of a larger unit.

**Assignment:** Assigned to a modular ammunition company headquarters (TOE 09408L000).

When deployed independently to perform the CSA function, platoons are assigned to a CSB (TOE 63426L000) or an ammunition battalion (corps) (TOE 09466L000).

When deployed independently to perform the TSA function, the unit is assigned to an ammunition battalion (EAC) (TOE 09666L000).

**Capabilities:** See Table 2-1 forklift capabilities.

**Basis of Allocation:** As required by theater operations, daily tonnage lift requirements, or theater ammunition stockage requirements.

**Mobility:** The platoon is 100 percent mobile, minus ammunition stocks. Unit depends on nonorganic transportation assets to move any ammunition supplies on hand. This platoon should expect to move every 3 to 10 days.

**Figure 2-9. Modular ammunition platoon (heavy lift)**

**Modular Ammunition Platoon  
Medium Lift (MLP)  
SRC 09503LA00**

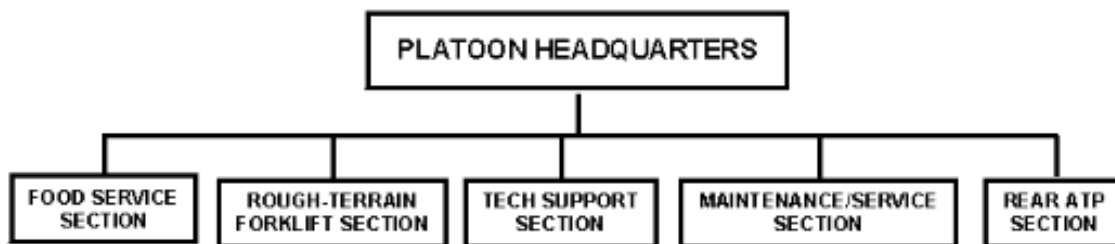

**Mission:** Receives, configures, inspects, issues, manages, ships, and retrogrades noncontainerized ammunition stocks. Operates independently or as part of a larger unit.

**Assignment:** Assigned to a modular ammunition company headquarters (TOE 09408L000).

When deployed independently or as part of a unit to perform the ASP or the CSA function, platoons are assigned to a CSB (TOE 63426L000); or when deployed to perform the CSA function, platoons are assigned to an ammunition battalion (corp) (TOE 09466L000).

When deployed independently or as a unit to perform the TSA function, the unit is assigned to an ammunition battalion (EAC) (TOE 09666L000).

**Capabilities:** See Table 2-1 for lift capabilities.

**Basis of Allocation:** As required by theater operations, daily tonnage lift requirements, or theater ammunition stockage requirements, and the number of modular ammunition platoons deployed.

**Mobility:** The platoon is 100 percent mobile, less ammunition stocks. Unit depends on nonorganic transportation assets to move any ammunition supplies on hand. This platoon should expect to move every 3 to 10 days.

**Figure 2-10. Modular ammunition platoon (medium lift)**

### AMMUNITION SUPPORT TEAM

The USAMC ammunition support team (AST) arrives at immature theater PODs before prepositioned munitions vessels, sustainment shipments, or munitions units. It establishes a point at the PODs where munitions stocks can be accounted for. Also, the team coordinates the off-loading and distribution of stocks either to storage areas or for direct issue to units from the PODs. Early arrival of ammunition units is essential to move Class V from the port area.

The concept for employing the AST is dissimilar to the employment of all other LSE organizations. The AST mission is tied specifically to the accountability and management of APS munitions. These preconfigured loads, stored on logistics ships, are available for rapid delivery to the theater.

During the early stages of any contingency operation requiring APS munitions, the AST deploys with mirror image prepositioned (APS) accountable records and quality assurance specialist (ammunition surveillance) (QASAS) support. Normally, this coincides with the deployment of the LSE advance party. The early departure of the AST from CONUS is necessary to assure that its arrival is before the port acceptance of the Army's APS vessels.

The AST provides technical expertise and assistance in the following areas:

- Supply.
- Storage.
- Maintenance.
- Surveillance.

- Demilitarization.
- Transportation.
- Security.
- Explosive safety.
- Supplies.
- Packaging.
- Accountability for munitions materiel and associated equipment.

AST responsibilities may include, but are not limited to, the following activities:

- Providing theater munitions units with technical assistance in establishing and managing ammunition storage areas.
- Conducting inventories. Maintaining initial theater-accountable records.
- Providing for the transfer of DA-owned, NICP-accountable Army reserve stocks assigned to the theater.
- Developing and administering contract statements of work.
- Planning and executing retrograde operations.

Deployment of the AST should be based on the tempo of logistical operations in the theater. The major functions of the AST include the following:

- Preparing for overseas deployment.
- Deploying to theater ports of debarkation.
- Setting up the support team base of operations.
- Transferring the accountability of APS assets from NICP-accountable officers to theater-accountable officers.
- Providing initial theater accountability and Standard Army Ammunition System (SAAS) operations.
- Linking the CONUS sustainment base and the combat logisticians.
- Submitting status reports through NICP to HQ, USAMC, and HQDA.
- Coordinating joint munitions operations as required.
- Providing initial QASAS support to the theater.

Once the AST has established itself in the theater, the ground component commander may expand the AST mission based on the specialized training and technical expertise of the team. Any expansion of responsibilities must be coordinated with the parent organization at the time, either the LSE or USAMC.

#### **Headquarters and Headquarters Detachment, Ordnance Battalion (Ammunition) (WHNS) (DS/GS)**

The mission of the headquarters and headquarters detachment, ordnance battalion (ammunition) (WHNS) is to command and control assigned or attached units (see Figure 2-11). This unit provides:

- Command, control, and staff planning for up to nine ammunition companies (TOE 09574LB000).
- Technical direction over ammunition support operations of subordinate units, the exception being inventory management functions for which the operational level MMC is responsible.

This detachment is also involved in the coordination and management of US-owned Class V stocks being received, stored, and issued by host nation (HN) ammunition units. It can be assigned to a CSG; it can also be assigned to an ammunition group in the TAACOM.

#### **Ordnance Company (Ammunition) (WHNS)**

The mission of the ordnance company (ammunition) (WHNS) is to provide operational control over US-owned ammunition stocks being received, stored, warehoused, and issued by HN units to US forces combat units. This company is assigned to an ordnance battalion (TOE 09574LA00) with one company allocated per HN ammunition company. On a 24-hour basis this unit provides:

- Expertise required to perform stock accountability, stock status reporting, and QA/QC functions for US-owned ammunition stocks being received, stored, warehoused, and issued by HN ammunition units.

- Coordination needed for maintenance support for US equipment operated by HN units.
- Coordination for operational task-ings.

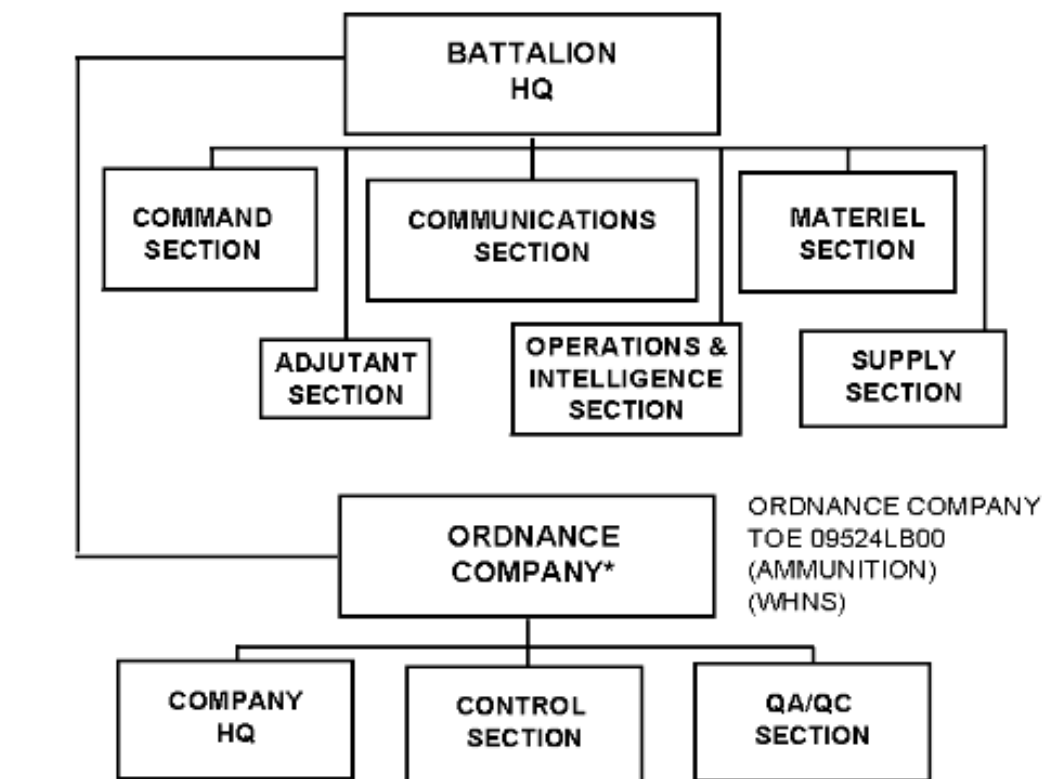

*\*Up to nine companies under the command and control of one ordnance battalion*

**Figure 2-11. Headquarters and headquarters detachment, ordnance battalion, ammunition (WHNS) (DS/GS)**

### **MUNITIONS FLOW IN THE THEATER**

The theater receives munitions from CONUS or OCONUS locations through air and water ports or by logistics-over-the-shore (LOTS) operations. From there, munitions are transported to the appropriate munitions support activity.

Several factors determine the quantity of munitions moved forward. These factors are as follows:

- Quantity of munitions on hand.
- Current and projected consumption.
- Available transportation.
- Available personnel and equipment.

### **Determining or Requesting Munitions Requirements**

Combat commanders control the flow of ammunition in their areas of responsibility by using two ammunition supply rates, the required supply rate (RSR) and the controlled supply rate (CSR). Commanders at each level submit their RSR to the next higher headquarters. These headquarters review, adjust, and consolidate RSR information and forward it through command channels. At the ASCC level, the total, unrestricted ammunition requirements are compared against total ammunition assets available (on hand or expected) to develop the CSR. Chapter 3 of this manual has more information about RSRs and CSRs.

To request ammunition, each unit consolidates its on-hand quantities and forwards its report to the battalion supply officer (S4), with information copies to the battalion commander and operations and training officer (S3). Company commanders will indicate in their situation report (SITREP) remarks any critical munitions shortages or forecasted changes in munitions requirements.

The battalion S4 requisitions ammunition based on information provided in the company SITREPs and guidance received from the

battalion commander and S3. The battalion S4 consolidates the entire battalion munitions requirement and submits it to the brigade S4. When necessary, battalion commanders cross-level within companies or throughout the battalion to meet mission requirements. The battalion S4 also reports the unit's on-hand quantities by Department of Defense Identification Code (DODIC) or nomenclature, any critical shortages, and any forecasted changes in requirements in the battalion's SITREP to the brigade.

The brigade S4 consolidates the requests for ammunition and passes them to the support operations officer in the supporting FSB. An information copy is forwarded to the DAO. The DAO, in conjunction with the corps materiel management center (CMMC), uses the information copy to determine if on-hand stocks in the ASP are sufficient or if munitions from the CSA or TSA will be required.

The brigade S4 monitors the munitions on the commander's tracked items list (CTIL) that require special attention, such as emergency resupply. The support operations officer consolidates the brigade's munitions requirements and forwards them to the division support command (DISCOM).

### **Controlled Supply Rate/ Priority of Issue**

The support operations officer, with guidance from the brigade S3 and S4, informs the DAO about the brigade's CSR breakout and unit priority of munitions resupply. Forecasted critical shortages and changes in requirements, as reported in the brigade SITREP, are provided to the DAO.

### **Munitions Resupply**

The preferred method of munitions resupply is to deliver as far forward as possible. Ammunition containers are shipped only to the TSA or CSA. There, they are unstuffed, and the ammunition configured into MCLs sent to forward ASAs. If the situation requires it or transportation assets are available, munitions may be throughput as close to the unit as possible. Figure 2-1 on page 2-3 illustrates the flow of munitions in the theater.

The CMMC determines whether the munitions resupply will come from the ASP or the CSA. The DAO determines the munitions status of the brigade ATPs in the division. This information will determine whether munitions within the division can be cross-leveled to meet munitions requirements.

If the munitions are coming from the ASP, the CMMC prepares a materiel release order directing the munitions shipment. If the munitions must be brought forward from the CSA, the CMMC submits a request for munitions resupply to the corps assistant chief of staff (logistics) (G4).

Munitions may arrive in theater in configured loads. The supporting activity, either the ASP or CSA, reconfigures these loads into MCLs before transportation assets arrive. The MCB schedules transportation according to corps priorities. The ammunition units are notified by the MCB of where and when transportation will arrive.

After ammunition has been loaded, the RF tags are verified along with the correct cargo and destination. All ammunition shipments are tracked through ITV. Delivery coordinates and time are forwarded to the receiving unit or activity, with information copies furnished to the DAO, the FSB support operations officer, the DAO representative, and the S4. In the event an ammunition shipment must be diverted within the brigade, the brigade commander or designated representative retains sole authority to do so. This is accomplished through the FSB support operations officer. Ammunition shipments that must be diverted within the division are directed by the division commander to the DISCOM commander for implementation.

### **AERIAL RESUPPLY**

Air resupply missions are categorized as preplanned or emergency. Preplanned missions make up the routine air transport service that supports preplanned or program-med requirements. Emergency air movements are initiated by requirements that cannot be determined in advance.

The movement control officer coordinates the movement of supplies with the main support battalion (MSB) and the movement manager in the FSB support operations section. If the movement control officer determines that air resupply is appropriate, he passes a request through the division transportation officer (DTO) to the assistant chief of staff (operations and plans) (G3). The G3 allocates helicopters on the basis of all aviation tasks by balancing combat, combat support (CS), and CSS requirements. The G4 must ensure the CSS role for helicopters is developed and considered concurrently with the tactical mission. The priorities for helicopter resupply should be addressed in the operations order (OPORD) and used by the movement control officer.

Emergency requests are passed through supply channels the same as routine requests. However, they are also passed simultaneously through command channels from the user to the G3. The G3 approves emergency requests and tasks the aviation

brigade to perform the mission. At the same time, the G4 coordinates with the DISCOM support operations branch so it can task the appropriate supply activity to prepare the shipment. A liaison officer from the aviation brigade coordinates with the movement control officer and the requesting unit. Prerigged loads of standard resupply packages may reduce response time for emergency air resupply. More details on requests for aerial resupply are in FMs 55-2 and 100-27.

### **COMMAND AND SUPPORT RELATIONSHIPS**

Army, joint, and/or combined units or elements may be required to perform their missions within the area of operations (AO) of a corps, division, brigade, or battalion with which they have no formal command or support relationship. Unless attached for logistical support, parent units are responsible for providing support to their elements dispersed throughout the battlefield. At times, mission requirements may exceed the organic support capabilities of the parent unit. When this happens, the parent unit must coordinate support for its elements with the headquarters controlling that element's AO. Once coordination is accomplished, the headquarters controlling the AO assumes responsibility for providing logistical support for the units in the AO. The rear command post (CP) facilitates support of nondivisional units by identifying the name and location of the divisional coordinating staff element or host unit.

Munitions support for nondivisional units operating in the division's AO is coordinated by the DAO. Nondivisional units attached to or supporting the brigade combat trains (BCTs) forward their munitions requests through the FSB support operations officer to the DAO. Nondivisional units attached to or supporting the division and operating in the division's rear area forward their munitions requests through the DISCOM support operations officer to the DAO. Specific procedures for supporting nondivisional units are detailed in the Class V section of the service and support annex of the OPORD.

### **FUNCTIONAL RESPONSIBILITIES**

Each activity or unit in the munitions supply system has functions unique to it. These functions are discussed below.

#### **Army Service Component Commander**

The ASCC has overall responsibility for in-theater receipt, accountability, and management of munitions stocks. The ASCC is also responsible for the following functions:

- Establishing ASPs, CSAs, and TSAs.
- Coordinating distribution between storage sites and storage sites and forward ATPs; coordinating direct issue to using units on an area support basis.

#### **Operational Level Materiel Management Center**

The operational level MMC is the support unit responsible for providing theaterwide munitions supply management and allocation. Support is based on priorities established by the theater CINC. The MMC is the prime interface between the theater and the CONUS sustaining base, which includes the Defense Logistics Agency (DLA), NICPs, and USAMC. The operational level MMC communicates with the operational level movement control agency (MCA), the TAACOM, CMMCs, and CONUS.

The MMC provides initial resupply to the corps from several possible theater ammunition sources, as follows:

- Army prepositioned stocks. This includes either ammunition preconfigured on logistics ships that is available for rapid delivery to the theater or prepositioned ammunition available on a regional basis to support contingencies worldwide.
- Sustainment base production stocks. This includes ammunition either off the production line or stored in depots. These stocks are shipped to the theater as needed.

#### **Corps Materiel Management Center**

When a corps is the ARFOR, the CMMC is the operational level MMC. In a theater with more than one corps, the ASCC may establish a centralized MMC to which CMMCs report.

The CMMC provides centralized control of munitions and all other classes of supply within the corps. It is the interface between corps units and the theater/operational level MMC.

#### **Missile and Munitions Division**

In the CMMC, the missile and munitions division includes three branches: the missile and munitions support branch; the missile and munitions parts supply branch; and the missile and munitions maintenance branch (see [FM 63-3](#)).

The missile and munitions division is responsible for ammunition management to include the following:

- Processing requisitions.
- Reviewing the RSR and computing the CSR.
- Directing storage and distribution of ammunition.
- Coordinating with the corps move-ment control center (CMCC) to integrate ammunition movement requirements into movement programs.
- Providing guidance to division mate-riel management centers (DMMCs).

### **Munitions Support Branch**

The munitions support branch exercises staff supervision over munitions support operations. These include supply and maintenance operations relating to muni-tions, missiles, special weapons, and associated repair parts, special tools, and test equipment. Responsibilities include:

- Developing plans and policies involving munitions supply and maintenance.
- Providing staff input for munitions planning to COSCOM CSS plans staff branch.
- Developing munitions surveillance policies.
- Maintaining a running estimate of munitions requirements.
- Coordinating munitions require-ments with corps G3 and G4 staff.
- Establishing ammunition supply levels based on corps directives.
- Recommending ammunition supply and storage site locations to the corps rear CP CSS cell.

Missile and munitions officers assigned to the munitions support branch develop operating procedures and plans to implement munitions supply policies prescribed in [ARs 710-1](#) and [710-2](#) and SAAS technical manuals (TMs). Other duties include:

- Providing technical advice and assistance to ammunition officers in subordi-nate CSGs and ammunition supply units.
- Coordinating with CSG ammunition officers on cross-leveling munitions support personnel and equipment.
- Recommending establishment and movement of ASAs as the situation dictates.
- Reviewing and updating ammunition planning factors to the theater scenario.
- Monitoring ammunition suspen-sions.
- Recommending adjustments to munitions stockage levels.
- Coordinating resupply of munitions stocks for attrited units at regeneration sites.

### **Ammunition Battalion Materiel Office**

In the absence of an ordnance group in theater, the conventional ammunition bat-talion is normally assigned to the COSCOM/TAACOM (Figures 2-3 and 2-4, pages 2-8 and 2-9) to establish and operate ammunition supply activities. The materiel office (MATO) of this battalion serves as the initial point of coordination for resolving ammunition support problems. The MATO acts in concert with the COSCOM staff and CMMC munitions and transportation managers to accomplish the following:

- Coordination of assets.
- Monitoring and cross-leveling of stocks.
- Directing the implementation of COSCOM/TAACOM support operations directives, CMMC/TAMMC taskings, and CMCC/theater army movement control center (TAMCC) commitments.

The MATO's responsibilities include the following:

- Analyzing CSS/CS data, which interfaces with SAAS to determine trends and efficiency of stock operations.
- Monitoring supply status data on munitions stock at ASAs.
- monitoring RSR, CSR, ammunition basic load (ABL), quantity on hand, and movement requirements data.
- Assisting in synchronizing activities of subordinate ammunition units with habit-ually supporting truck companies.



- Providing technical assistance and monitoring quality assurance, ammunition surveillance, and ammunition maintenance programs of subordinate units.
- Coordinating with the COSCOM/ TAACOM on cross-leveling munitions support personnel and equipment.
- Recommending to the COSCOM/ TAACOM that, when in-transit, ammunition stocks should be diverted based on METT-T.

### **Division Materiel Management Center**

The DMMC is part of the DISCOM (see [FM 63-2](#), Chapter 3). The munitions supply section of the DMMC manages ammunition for the division. The DAO is in charge of the munitions supply section. Its mission includes the following:

- Providing technical assistance on all ammunition-related matters to the division staff and units.
- Assisting the division, brigade, and battalion commanders in determining RSRs and implementing CSRs.
- Managing ammunition and providing status of ammunition to the DISCOM and other division commands and staffs.
- Providing staff supervision of FSB ATPs.

### **Division Ammunition Officer**

The DAO is responsible for ammunition resupply for all units operating in the division AO. He represents the MMC and DISCOM commander on all ammunition-related matters. The DAO has five broad missions:

- Consolidating division ammunition requirements.
- Preparing plans and procedures for ammunition operations.
- Maintaining ammunition stock records and reports (Standard Army Ammunition System-Modernization [SAAS-MOD] data entry point). (See Appendix.)
- Conducting and supervising ammunition operations.
- Validating ammunition requests.

The DAO maintains liaison with the ASA supporting the division and with ammunition staff officers at the COSCOM.

### **Brigade S3**

The brigade S3's ammunition responsibilities include:

- Determining brigade ammunition requirements based on input from subordinate battalions and knowledge of upcoming tactical operations.
- Determining consolidated brigade RSR and submitting it to the division G3 and DAO.
- Determining the best location for the BSA.

### **Brigade S4**

The brigade S4 ammunition responsibilities include:

- Coordinating an issue schedule with the support operations office, FSB, and the DS ammunition company ATP.
- Providing a unit issue priority list to the DAO. Forwarding the consolidated unit ammunition requirements to the DAO.
- Providing subordinate battalion S4s with their allocations of the brigade CSR. (This information is also provided to the DAO so battalion units do not exceed their authorizations when transloading at the ATP.)

### **Forward Support Battalion**

The Class V section of the FSB supply company operates one ATP in the BSA. It provides area support to division and corps units. Each ATP has DAO representatives assigned to control the flow of ammunition.

When munitions arrive at the ATP, the FSB Class V section inspects, inventories, and signs for the shipment. A copy of the shipping document is returned to the originating ASA. The DAO representative forwards a copy of the receipt document to the DMMC.

The brigade S4 coordinates with the FSB support operations officer to establish an issue schedule. When supported units arrive at

the ATP, they submit ammunition requests that have been authenticated by the battalion S4. Before a unit is issued ammunition, the DAO representative at the ATP validates the request. Once ammunition is issued to a unit, the unit assumes accountability and uses its transportation assets to move the ammunition forward.

---

---

## CHAPTER 3

### MUNITIONS PLANNING AND EXECUTION

#### PURPOSE AND SCOPE

The object of the munitions distribution system is to provide munitions at the right time, place, and quantity to ensure the success of an operation. Munitions planning and operations must be versatile. They must complement combat plans and operations and improve the ability of the supported unit to accomplish its mission.

The supported commander's concept of operations, priorities, and allocations dictates the actions of the ammunition planner. Am-munition planning includes:

- Determining ammunition require-ments.
- Echeloning capabilities and ammuni-tion units.
- Establishing split-based operations.
- Preconfiguring ammunition basic loads and resupply amounts.
- When required, using civilian con-tractor, allied, and HN capabilities.

#### CONVENTIONAL AMMUNITION ALLOCATIONS

The Deputy Chief of Staff for Opera-tions and Plans (DCSOPS) is responsible for developing munitions programming and budgeting requirements. Requirements determination establishes what is essential to support a strategy, campaign, or operation. During a conflict, resupply quantities must constantly be reviewed and adjusted based on historical usage data gathered as the conflict progresses.

#### Operational Planning Factors

The United States Army Combined Arms Support Command (USACASCOM) validates munitions operational planning factors. The Deputy Chief of Staff for Logistics (DCSLOG) is the approving agency. An automated tool called the Operational Logistics (OPLOG) Planner is the authorized method for determining munitions planning data at all levels. **FM 101-10-1/2 is not an authorized tool for determining operational ammunition planning factors.**

Ammunition consumption rates for all operations, including SASO, are determined using the OPLOG Planner. Units base their ammunition requirements on METT-T, their projected mission, and the supported commander's concept of the operation and intent. Developing ammunition requirements for using units is the responsibility of their operations section. To obtain the OPLOG Planner software, write to:

**Force Development Division  
DIR OF CBT DEVS CBT SVC SPT**

**700 Quarters Road Suite 210  
Fort Lee VA 23801-1703**

## **Ammunition Basic Load**

Ammunition basic load is that quantity of ammunition either allocated to or issued to (depending on the major Army command's [MACOM's] policy) a unit to sustain its operations in combat until it can be resupplied. Basic load requirements are based on unit weapons density and mission requirements. Units must be able to transport ABL using organic vehicles, equipment, and personnel.

## **Munitions Control Procedures**

To sustain tactical operations for specific periods, units determine their munitions requirements and submit an RSR. The RSR is the amount of ammunition a maneuver commander estimates will be needed to sustain tactical operations, without ammunition expenditure restrictions, over a specified time period. The RSR is expressed as rounds per weapon (on hand) per day, or as a bulk allotment per day or per mission.

RSR computation and routing are normally done by unit S3/G3s. As such, it is not a logistics function, but the S4/G4 may be called on to assist in the process. RSRs can be computed using manual or automated procedures. Weapons density (WD) and mission are key to determining RSR. Determine RSR using the following formula:

$$\text{Total Rounds} = \text{WD} \times \text{Expenditure Rate} \times \text{Days}$$

RSRs are developed by maneuver commanders and submitted to the next higher headquarters. Headquarters at each level review, adjust, and consolidate RSR information and forward it through command channels. The ARFOR determines the CSR by comparing the total unrestricted ammunition requirements against the total ammunition assets on hand or due in.

Several factors limit the amount of ammunition available for an operation (e.g., stockage or lift capabilities). Accordingly, ammunition issues are controlled by CSRs. The ARFOR establishes the CSR, which is based on the amount of munitions available for issue. When a munitions item is in short supply, the CSR is low. The commander determines who receives the ammunition. The DAO informs the G3 of the quantity available.

The ARFOR commander gives the corps commanders the CSR for each ammunition item. The CSR may vary from corps to corps based on the mission objectives and priorities of each corps, the projected threat, and ammunition availability. The corps gives subordinate combat commanders their unit CSR. Each combat commander gives the CSR to each subordinate combat commander. Commanders making CSR allocations to subordinate units should retain a portion of the CSR to meet unforeseen contingencies. The CSR is disseminated to units through the OPORD. The CSR should appear in the OPORD in paragraph 4, or in either the service support or fire support annex.

The ammunition requirements of other services and coalition members must be considered when computing the RSR and CSR. Also, ammunition items in the Army inventory that are unique to other services or coalition members must be considered in supply rate computations. Figure 3-1 illustrates the

flow of RSRs and CSRs.

## LOGISTICS PREPARATION OF THE THEATER

At the strategic level, logistics preparation of the theater (LPT) combines the peacetime actions taken by logisticians at all echelons to maximize means (e.g., force structure, resources, and strategic lift) of logistically supporting the commander's plan.

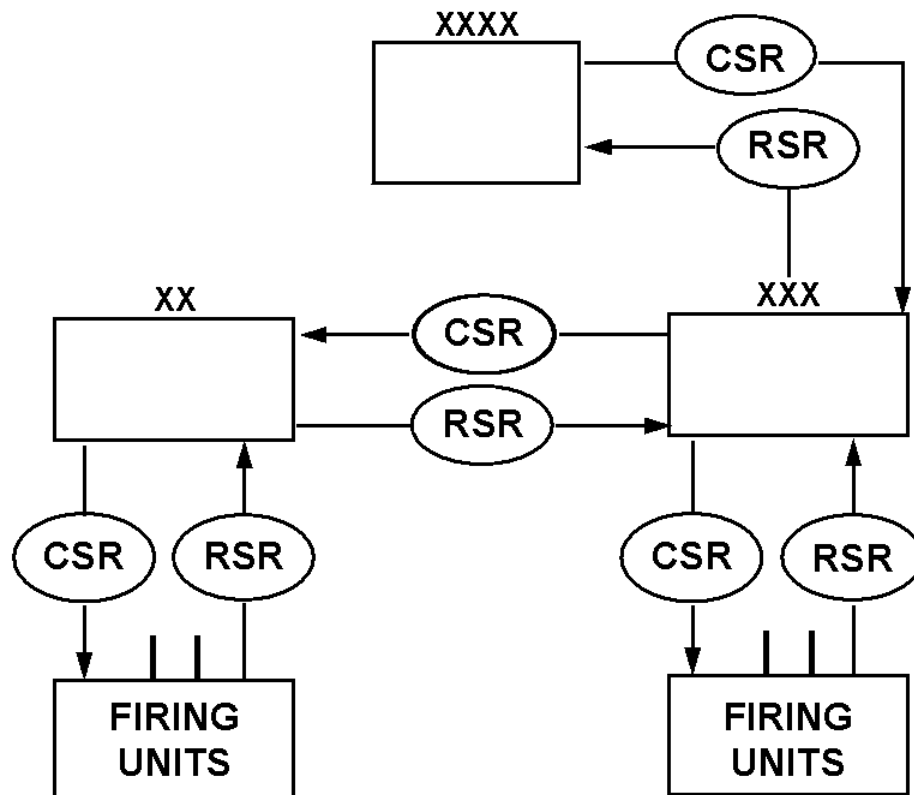

**Figure 3-1. Ammunition supply rate flow**

For the ammunition planner at DA, planning is based on the Defense Planning Guidance (DPG). The DPG provides scenarios that are modeled and integrated into Army force structure, budgeting, procurement actions, and operational plans (OPLANs). Ammunition planning at the DA level considers the following:

- Mission synchronization.
- Threat capabilities.
- Production base.
- Transportation assets.
- Consumption rates determined by the US Army Concepts Analysis Agency (USACAA).
- Depot stocks.
- Prepositioned stockage afloat.
- Worldwide ammunition stocks.
- Echeloning of units using time-phased force deployment (TPFD).

At the operational and tactical levels, logistics preparation of the battlefield is as critical as intelligence preparation of the battlefield (IPB). Some products generated under IPB should become a part of the data file of logistics essential elements of information. The ammunition planner uses the tactical commander's mission analysis to ensure a complete understanding of what must be accomplished. The ammunition planner participates in the orders process by preparing the munitions piece of the logistics estimate.

### **Movement**

The logistics planners supporting the ASCC and geographic combatant commander must consider total force ammunition requirements when planning for the movement of stocks and support forces. The number of HLPs in a theater must be considered prior to requesting containerized ammunition. For more information on this aspect of planning, see [FM 100-16](#).

### **Communications**

Ammunition units must have reliable communications to accomplish their mission. Effective communications networks must be established to ensure the success of ammunition support in the theater of operations. These networks must relay accurate and timely information between supported and supporting units, the MMCs, and the DAO. Also, they must interface with the combat and combat support networks of units supported by ammunition units. The most critical link is the one between the accountable SAAS level and those responsible for stock status reporting. This link provides necessary data to the ASCC, enabling crucial decisions to be made in support of the combat force.

### **Joint Operations**

Joint integration of ammunition support is crucial to unity of effort. Army ammunition units will support the requirements of other services during joint operations. In computing the RSR/CSR, these requirements must be forecasted and considered. Failure to plan for this support may result in severe shortages of critical ammunition items and handling capability.

Plans must consider efficiencies gained by having integrated ammunition support. The plans must be coordinated with the various services involved to ensure adequacy of personnel, storage requirements, MHE, accountability procedures, and safety.

### **Combined and Coalition Operations**

Combined and coalition logistics operations (see [FM 100-7](#)) require integration for unity of effort. Procedures for ammunition support must be worked out during the planning phase of a deployment or operation. This ensures interoperability and that handling capability is available. During emergency deployments, there may not be time to develop formal intercountry agreements. Planners must develop methods to preclude competition for resources, particularly infrastructure and LOCs, that could adversely affect operations.

Planners should consider options for contracting, acquiring host nation support (HNS), or obtaining support from other national forces, and then integrating this support into the multinational force.

---

---

## **CHAPTER 4**

### **RETROGRADE OPERATIONS**

#### **PURPOSE AND SCOPE**

During operations Just Cause, Urgent Fury, Desert Storm/Desert Shield, and Joint Endeavor, huge amounts of munitions were requisitioned and issued to deploying forces. A large part of these munitions was not expended, and the stockpile that resulted placed an enormous strain on the ammunition support system. To reduce this burden, retrograde operations must be included in the initial planning of every exercise and operation—not when the exercise/operation is drawing to a close. Planning and responsibility for retrograde operations depend on the theater. Based on mission requirements and characteristics of the force to be supported, responsibility can range from an ammunition group to a platoon.

Another critical issue is soldier casualties from improper handling and repackaging of munitions. Leaders often fail to enforce discipline during the unpacking, restoration, and reconstitution of ammunition. Also, leaders do not maintain accountability of the packing materials needed to carry out retrograde operations.

This chapter provides information on what leaders must do to return ammunition to a serviceable condition upon termination of a conflict. Well before the operation ends, leaders must develop plans outlining retrograde procedures. These plans must identify the tasks required to return ammunition to its original packing configuration.

#### **REDEPLOYMENT AND RETROGRADE**

Upon completion of combat operations or SASO, the tedious job of identifying, preparing, repackaging, requisitioning, collecting, loading, and shipping ammunition begins. These tasks constitute the redeployment process and signal the start of the munitions retrograde program within the ammunition supply system.

To ensure effective retrograde operations, leaders must enforce supply discipline during the initial unpacking of ammunition. This includes maintaining salvage and packing materials to be used in retrograde. Tremendous resources are needed to restore and repackage ammunition. Besides indigenous assets, contractor and HNS may be required.

Before a redeployment begins, and while combat operations are raging, logistical planners monitor the levels of munitions in the theater. They then estimate the packing materials needed to retrograde munitions from the using unit, through ammunition storage activities, to a theater depot or port, and to a CONUS depot.

During retrograde operations, munitions units continue to provide munitions to security forces while relocating the excess to a CSA or TSA. To support forward units, CSAs prestock limited amounts of munitions behind selected division security forces. Surplus stocks are consolidated and shipped to CONUS or diverted to support other operations. ASPs should contain only those stocks needed to

support security forces, making unnecessary the retrograde of munitions from the ASPs.

### **Retrograde Planning**

Operational planning incorporates a vast array of critical issues and concerns. One of the key issues planners must address during the initial phases is how to recover and retrograde ammunition remaining after the operation or exercise ends.

Redeployment plans differ significantly from the deployment plans made before leaving CONUS. Personnel, time, equipment, and materiel become more important when the main effort is directed at returning personnel and equipment to CONUS as quickly as possible. At a minimum, planners should consider the following:

- Begin planning before the last battle.
- Develop a retrograde system that consolidates materiel at various stages; e.g., at unit level to return to an ATP area.
- Assign condition codes as far forward as possible. Also, make decisions about which ASP should get certain items for further consolidation or reconditioning.

For planning purposes, assume the following about the condition of munitions in a unit's or soldier's possession:

- Munitions have been removed from original packing.
- Packing materials have not been retained by the users.
- Munitions will require a service-ability or classification inspection.

At all levels, plans must incorporate retrograde operations. These plans should include:

- Retrograde responsibilities of headquarters, MMCs, supporting ammunition units, and using units. Responsibilities encompass reporting requirements, pack-aging, storing, consolidating, and security.
- Obtaining and providing empty storage containers, as well as other materials needed to build and repair pallets and containers.
- Forming retrograde planning cells.
- Identifying special requirements for classified, Category I, or critical sensitive items.
- Contacting USAMC to request specialized teams or personnel to assist in retrograde.
- Responsibilities for recovery of packing materials.

During the various stages of buildup and actual conflict, arrangements must be made for the recovery and storage of packing materials. These materials can occupy an extraordinary amount of space. They can be backhauled to a central location or stored in a separate area near the CSA, or in any other area having the capability and capacity.

The following factors should be considered before actual retrograde operations begin:

- Existing facilities.
- Existing logistical support.
- Shipping point from theater.



- Available HN support.
- Available Logistics Civilian Aug-mentation Program (LOGCAP) support.

Visibility and accountability must begin at the returning unit level. If it has not, then it must begin at the ATP/ASP level. This is particularly true with Category I and serial-numbered items.

Accountability problems increase during war; however, as much as possible, the accountability of packing materials must be maintained. If this is done successfully, shortages will be easier to identify and correct.

Generally, packing materials used by opposing forces should not be used; they can be misidentified and usually are not of the proper size or quality for US items. However, they can be used for retrograde of captured enemy items.

When retrograded munitions reach the designated ASA, they must be accounted for, reconfigured, repackaged, and assigned a condition code. A QASAS or other qualified person must make condition code decisions.

If proper packing materials are not available, munitions must be inspected to determine their serviceability. If the munitions are in serviceable condition but have no lot number, a local lot number may be assigned. These munitions are considered as serviceable.

During retrograde operations, unserviceable munitions are typically destroyed. The responsible ammunition company must request disposition instructions through the MMC to the USAMC before destroying the munitions.

Captured enemy ammunition (CEA) must be kept separate from US munitions, accounted for, stored, and guarded using the same criteria that apply to US munitions.

If contractor/HN support is to be used for retrograde operations, it must be negotiated early in the operation. Contractors must know and fully understand the scope of work necessary to complete the mission. HNS should be thoroughly screened by security personnel to ensure clearances are granted and the correct US/HN ratio is negotiated before work begins.

During retrograde operations, leaders must ensure safety policies and procedures are carefully observed. These operations can be particularly hazardous for the following reasons:

- Careless attitudes may prevail. Absence of battle and relief that the operation is over may cause soldiers to become so relaxed they become careless.
- Collection of battlefield souvenirs may include dangerous unexploded ordnance (UXO).
- Taking dangerous shortcuts may result in serious injury. As above, the absence of battle and the excitement soldiers experience at thoughts of going home may contribute to lax behavior, including the careless handling of ammunition and explosives.

Once ammunition has been inspected, repaired, repackaged, and deemed serviceable or unserviceable by surveillance personnel, it must be retrograded out of the theater.

## **DESTRUCTION OF AMMUNITION**

Commanders must follow applicable environmental regulations when destroying munitions. Failure to obey environmental laws and regulations may subject commanders to fines and/or imprisonment. For more information, see Chapter 6, Section I, of this manual; [FM 20-400](#) (projected publication, FY 98); and [TC 5-400](#).

The two categories of ammunition destruction are routine and emergency. Routine destruction occurs during normal day-to-day operations (for example, the destruction of unserviceable ammunition).

### **Routine Destruction**

The destruction of ammunition is based on METT-T. However, a general plan for the destruction of unserviceable ammunition and CEA must be prepared for every storage activity. The destruction site should be carefully selected so that explosive fragments, debris, and toxic vapors do not become a hazard to personnel, materiel, facilities, or operations. For more information on selecting a destruction site, see [FMs 5-250](#) and [9-13](#) and [TM 9-1300-206](#).

Ammunition personnel must receive permission from their chain of command before destroying unserviceable ammunition. Ammunition destruction should be supervised by a QASAS. For information on the emergency destruction of storage sites, see [FM 9-13](#), [TM 43-0002-33](#), and the field SOP.

At the segregation area, unexpended ammunition is identified and segregated by type and lot number, checked for nonstandard or hazardous conditions, and repacked or palletized and stored IAW distances outlined in [TM 9-1300-206](#). In established theaters of operation, surveillance activities are controlled by QASASs. QASASs inspect and classify ammunition and its components during movement, storage, and maintenance operations. Also, they inspect equipment, facilities, and operations. A 55B sergeant first class (SFC) or above, or a QASAS, visually inspects all opened ammunition and determines the serviceability of both the ammunition and its containers. Also, inspectors must check for compatibility and ammunition in a hazardous condition.

Added precautions should be taken when handling ammunition containing depleted uranium (DU). (See [TB 9-1300-278](#).)

### **Emergency Destruction**

Emergency destruction of ammunition prevents the ammunition from being captured by enemy forces. Only division commanders and above have the authority to order the emergency destruction of ammunition. This authority may be delegated to subordinate commanders. [TM 43-0002-33](#) is the reference for emergency destruction of ammunition.

If it is necessary to conduct emergency destruction operations, the ammunition must be rendered unserviceable. When possible, emergency destruction should be planned and conducted to impede enemy troop movements without creating hazards to friendly troops.

The first priority for emergency destruction is classified ammunition and its associated documents. The second priority is ammunition that the enemy could immediately use against friendly forces, such as hand grenades or land mines. Also second priority is any ammunition that the enemy could use in their weapons.

## **AMMUNITION**

## MAINTENANCE

To ensure that ammunition is returned to a high state of readiness, maintenance must sometimes be performed after it is inspected. Maintenance operations include minor packaging and preservation operations (PP), such as:

- Cleaning.
- Minor rust and corrosion repair.
- Repair and replacement of boxes and crates.
- Restenciling of containers.
- Desiccant replacement.

Maintenance may also include major operations, such as complete renovation. Units should be prepared to perform as much PP as possible to maintain ammunition in a serviceable condition. In most cases, ammunition that becomes unserviceable will require evacuation or retrograde to a depot. However, since the movement of ammunition involves not only safety but also tremendous tonnages, it is not possible to adopt a maintenance policy geared totally to evacuation. Ammunition determined to be unserviceable must be reported on an Ammunition Condition Report (ACR), [DA Form 2415](#), and disposition instructions requested. Ammunition reported on an ACR should be tagged and segregated pending final disposition. Ammunition coded Condition Code H will be stored in a separate location pending disposition. Condition Code H ammunition that poses an immediate threat may be destroyed prior to the receipt of disposition instructions.

All units that have ammunition on hand, including using units, perform organizational maintenance with technical assistance from ammunition units.

Ammunition units will perform PP operations as required to prevent further ammunition deterioration. If added maintenance is required, it will be accomplished as determined by the National Maintenance Point (NMP). All maintenance operations are performed according to a maintenance SOP derived from [TM 9-1300-250](#) under the supervision of a qualified ammunition inspector as approved by the commander. Ammunition maintenance is discussed further in Chapter 6, Section IV of this manual.

## PHYSICAL SECURITY

When the war is over, the enemy threat changes. Even though the enemy has been officially defeated, there may be pockets of resistance, guerrilla units, or terrorists that want to continue the fight. Leaders must keep this in mind and develop effective physical security plans to prevent the capture or destruction of munitions stocks. Follow guidance in [AR 190-11](#) and [FM 19-30](#) for physical security of ammunition and explosives.

MPs provide security on an area support basis. However, commanders of ammunition units must ensure that their unit has developed an effective security plan based on applicable regulations, command directives, and the tactical situation. At a minimum, the plan must include the following:

- Unit mission.
- Current tactical situation.
- Level of threat expected.

- Available resources.
- Unit vulnerability.

The security plan must consider all aspects of physical security. These include:

- Access control.
- Guard force operations.
- Personnel screening.
- Document and materiel account-ability.
- Emergency actions.

Particular care must be given to providing security for Category I and II munitions items. [AR 190-11](#) contains the guidance required to secure properly Category I and II munitions.

Category I includes non-nuclear missiles and rockets in a "ready to fire" configuration. Also, it includes explosive complete rounds for these missiles, such as the Stinger, LAW, and AT-4.

Category II includes high explosive and white phosphorous hand and rifle grenades, antitank and antipersonnel mines with an unpacked weight of 50 pounds or less, and demolition explosives.

## **TRANSPORTATION AND STORAGE**

When transporting or storing ammunition and explosives for retrograde, use the same precautions and procedures used for these munitions during the buildup. Theater/corps trucks retrograde munitions stocks to designated locations. The CMCC/TAMCC regulates all highway movement during the retrograde operation. It identifies evacuation routes, publishes movement schedules, and designs a battlefield circulation plan. The theater/corps transportation system will be severely taxed by the movement of units, supplies, and equipment, and the CMCC/TAMCC may need to request added transportation from HN or theater transportation assets.

The ASCC, theater movement control agency (TMCA), and transportation command (TRANSCOM) coordinate with HQDA agencies and the NICP for instructions on relocating ammunition to CONUS or other theaters for subsequent operations.

### **Containers and Packing Materials**

ASAs normally are the primary consolidation hubs for turned in or backup ammunition storage containers and packing materials. Also, materials for building or repairing pallets and storage containers are consolidated at this location.

### **Retrograde Turn In**

Using units normally return munitions identified for retrograde to the ASA that provides their ammunition support. However, because of the changing requirements of the modern battlefield, units may be directed to turn in the identified ammunition and explosives to the nearest ASA. ASAs collect, consolidate, and ship this ammunition as directed.

---

---

## CHAPTER 5

### EXPLOSIVE ORDNANCE DISPOSAL SUPPORT STRUCTURE

#### OVERVIEW

EOD support is designed to detect, identify, render safe, recover, evacuate, and dispose of items of unexploded US and foreign ordnance. This chapter defines an EOD incident, explains how response priorities are established, and introduces the EOD support structure. For more on EOD force structure, see [FM 9-15](#).

#### EOD ROLE

The mission of EOD is to support the national security strategy during peacetime, wartime, and SASO by reducing or eliminating the hazards of explosive ordnance that threaten personnel, operations, installations, or materiel.

In all operations, EOD participates in security and advisory assistance, anti-terrorism, counterdrug operations, training, ordnance disposal, arms control, treaty verification, and support to domestic civil authorities. Many of these tasks are routinely performed in CONUS and include the following:

- Providing EOD support to the United States Secret Service (USSS) and other federal agencies for presidential and VIP protection.
- Advising and assisting the civil authorities in the removal of military ordnance that threatens public safety. See [AR 75-15](#) for authorization information.
- Examining, identifying, and report-ing new and unusual explosive ordnance for technical intelligence purposes.
- Supporting nuclear and chemical weapons shipments.
- Conducting range clearances. EOD supports range clearance operations by disposing of UXO on impact areas.
- Destroying ammunition (see [FM 9-15](#)).
- Neutralizing of government-owned ordnance shipments (see [FM 9-15](#)).
- Responding to improvised explosive devices (IEDs).
- Advising on mines and minefield clearance. Mines and minefields are not specifically an EOD matter. EOD personnel give technical advice and assistance when asked and when priorities allow. Large-scale minefield breaching is an engineer function.
- Supporting the cleanup of UXO from formerly used defense sites and active installations.
- Providing instruction to host or allied nation military or civilian EOD person-nel on UXO hazards and disposal techniques.

During war, preserving the com-mander's combat power becomes more challenging for EOD because of

the increasingly complex and lethal battlefield. EOD integration into staff planning must be sufficiently explicit to provide for battle synchronization, yet flexible enough to respond to change or to capitalize on fleeting opportunities. EOD command and control itself must respond quickly and adapt to the rapid changes on the battlefield.

UXO, including improved conventional munitions (ICMs), is emphasized now more than ever before because of its potential negative impact on the commander's combat power. ICMs (because of their sheer numbers, various means of functioning, and enhanced lethality) have significantly impacted EOD efforts to preserve the commander's combat power and provide a safe operational environment for all friendly forces on the ground. EOD missions include:

- Detecting UXO hazards.
- Identifying unexploded US and foreign ordnance.
- Rendering safe UXO.
- Recovering UXO for technical intelligence exploitation.
- Disposing of UXO.
- Advising commanders on UXO hazards and protective measures.

EOD provides the force projection Army with rapidly deployable support for the elimination of UXO from any operational environment. EOD serves as a combat force multiplier by neutralizing UXO that is restricting freedom of movement and denying access to supplies, facilities, and other critical assets. For detailed information on EOD support, see [FM 9-15](#).

## **EOD INCIDENTS**

An EOD incident occurs when a unit detects or suspects the presence of UXO or damaged ordnance that presents a hazard to operations, installations, personnel, or materiel. Anyone can detect and report an EOD incident through command or operations channels.

the operations officer at either the corps tactical operations center (CTOC) or TAACOM operations center prioritizes EOD incidents according to the priorities established by the corps or ARFOR. (For example, a Priority 1 asset may be an ASP and a Priority 2 asset, a POL point.) Once incidents have been prioritized, they are referred to the EOD staff officer.

Upon receiving the incident list, the EOD staff officer assigns each incident a category designation. The EOD categories are as follows:

**Category A.** Incidents that constitute a grave and immediate threat: "war-stoppers." These incidents are first in priority for EOD support.

**Category B.** Incidents constituting an indirect threat.

**Category C.** Incidents constituting little threat.

**Category D.** Incidents constituting no threat at the present time.

The priority and EOD category assigned each incident together determine the order in which the incidents will be handled.

The EOD staff officer forwards the incident workload list to the supporting EOD battalion. The EOD

battalion, in turn, assigns the incidents to its subordinate companies for elimination of the suspected UXO hazards.

## **CONTROL PROCEDURES**

The limited EOD assets available to the commander are force multipliers that far exceed their actual numbers. For that reason, EOD operations must be controlled in a manner that has the greatest impact on supporting the commander's mission. centralized control and decentralized control are the two methods of controlling the operations of EOD units.

### **Centralized Control**

Centralized EOD control relies on good communications and a complete and accurate evaluation of the threat to the war effort. Once the EOD battalion receives the request for EOD support (relayed through the TAACOM or corps command post from the requesting unit's operations channels), the EOD battalion assigns the incident to an EOD company. The EOD company then dispatches an EOD response team to handle the incident. Figure 5-1 illustrates centralized EOD incident reporting.

### **Decentralized Control**

Decentralized EOD control is used most often in peacetime operations. A unit needing EOD support requests that support directly through operational channels. The EOD company receives the request, notifies the EOD battalion, and dispatches a response team. Decentralized control works well in peacetime or when there is no requirement for a massive response by a large number of EOD assets to a major incident (e.g., a large-scale attack with denial-type munitions on a key facility).

The decentralized method depends less on total area communications than does the centralized method. With good communications, the centralized method is more flexible and responsive to changing situations. If communications support is not reliable, and massing EOD assets is not required, the decentralized method is best since it is less vulnerable to communications failure. With the decentralized method, each subarea can operate independently while the EOD battalion monitors the reported incidents. Figure 5-2 illustrates decentralized EOD incident reporting.

## **TRANSITION TO WAR**

Assigned EOD assets must be incorporated into the war plans of separate divisions, corps, and TAACOMs. This includes coordination with rear area operations center (RAOC) and HN EOD units. Also, planning must include coordination between peace-time CONUS EOD units and their wartime OCONUS higher headquarters.

## **SUPPORT STRUCTURE AND OPERATIONS**

EOD support is provided geographically to units both in and passing through the area. Also, support may be provided for maneuvers by assigning or attaching EOD units to maneuver forces.

### **User Level Support**

Any unit can report an EOD incident through operational or command channels to a central operations

center. The center can be a division tactical operations center (DTOC), CTOC, or the TAACOM operations center. The center's operations officer, with assistance of the EOD staff officer, sets the priority of EOD incidents based on the threat posed by the incident. Incidents are coordinated, based on the operational mode used, through the EOD battalion or company for the assignment of an EOD response team. Lastly, the EOD response team is dispatched to the scene.

### **EOD Response Team**

Basic EOD support is normally provided by a two- (light) or three-person (heavy) response team organic to an EOD company. The team may function independently of the parent company for up to 72 hours before returning to the company. Also, several light teams can be grouped to work on large multi-UXO incidents or other high priority incidents. If required, a response team may be attached temporarily to a unit other than its parent company for rations, quarters, and logistical support. However, command and control remain with the parent company.

A responding EOD team may need added support (e.g., engineers, medical) to reduce potential and/or actual hazards. The responding EOD team will advise if added support is needed and what type is required.

### **EOD Company**

The EOD company provides command and control for its organic EOD response teams. The mission of EOD companies is to provide EOD support to corps and TAACOM units. In the TAACOM, they provide DS to the ASG by covering the ASG area of operations and all units within it. Any EOD companies not DS to the ASG will be in GS to the TAACOM.

In the corps, EOD companies are positioned throughout the CSG AO and are normally collocated and attached to the CSBs. Command and control remain with the parent EOD battalion. EOD companies provide GS to the corps on an area basis and can be placed in DS of a specific maneuver unit, normally a division or task force equivalent element.

Because of limited personnel and equip-ment assigned to an EOD company, the company depends on the unit to which it is attached or supporting for rations and administrative and logistical support. EOD companies have a limited number of personnel available for base security and other details.

### **EOD Company (CONUS-Based)**

The CONUS-based EOD company provides command and control for its organic EOD response teams. Its mission is to reduce or eliminate the hazards of munitions and explosive devices throughout the continental United States.

This company provides EOD service on an area basis for a maximum routine incident response capability of 120 incidents per day (based on 12 teams). Also, it may respond to civilian requests for EOD support and assist public safety and law enforcement agencies in handling IED and terrorist threats. The CONUS-based EOD company may provide support to other federal intelligence agencies as outlined in DOD directives and support installations by clearing ranges and destroying unserviceable ammunition.



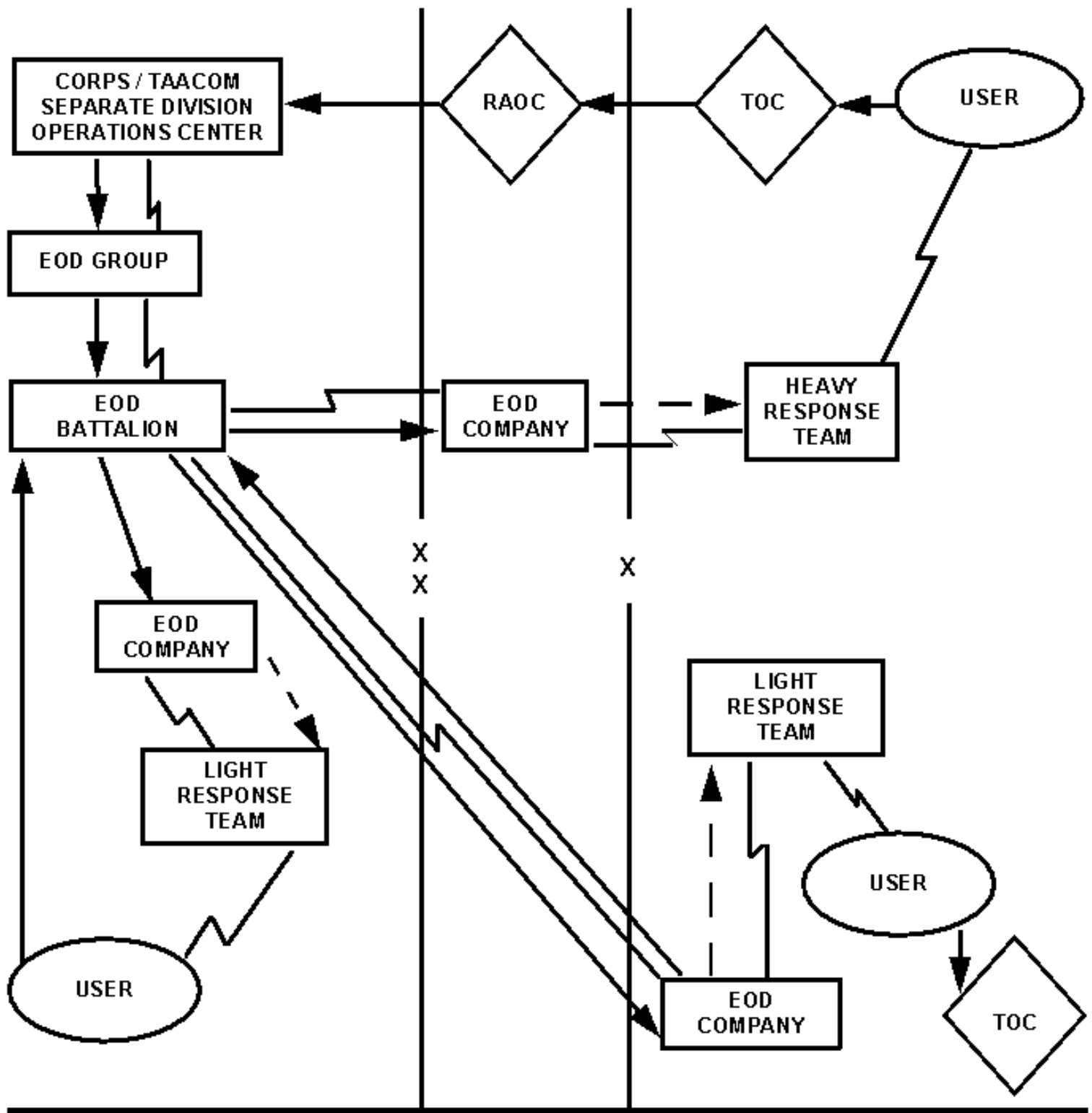

-  *RESPONSE TEAM DISPATCH*
-  *SECURE COMMUNICATIONS*
-  *NOTIFICATION*

**Figure 5-1. Centralized EOD incident reporting**

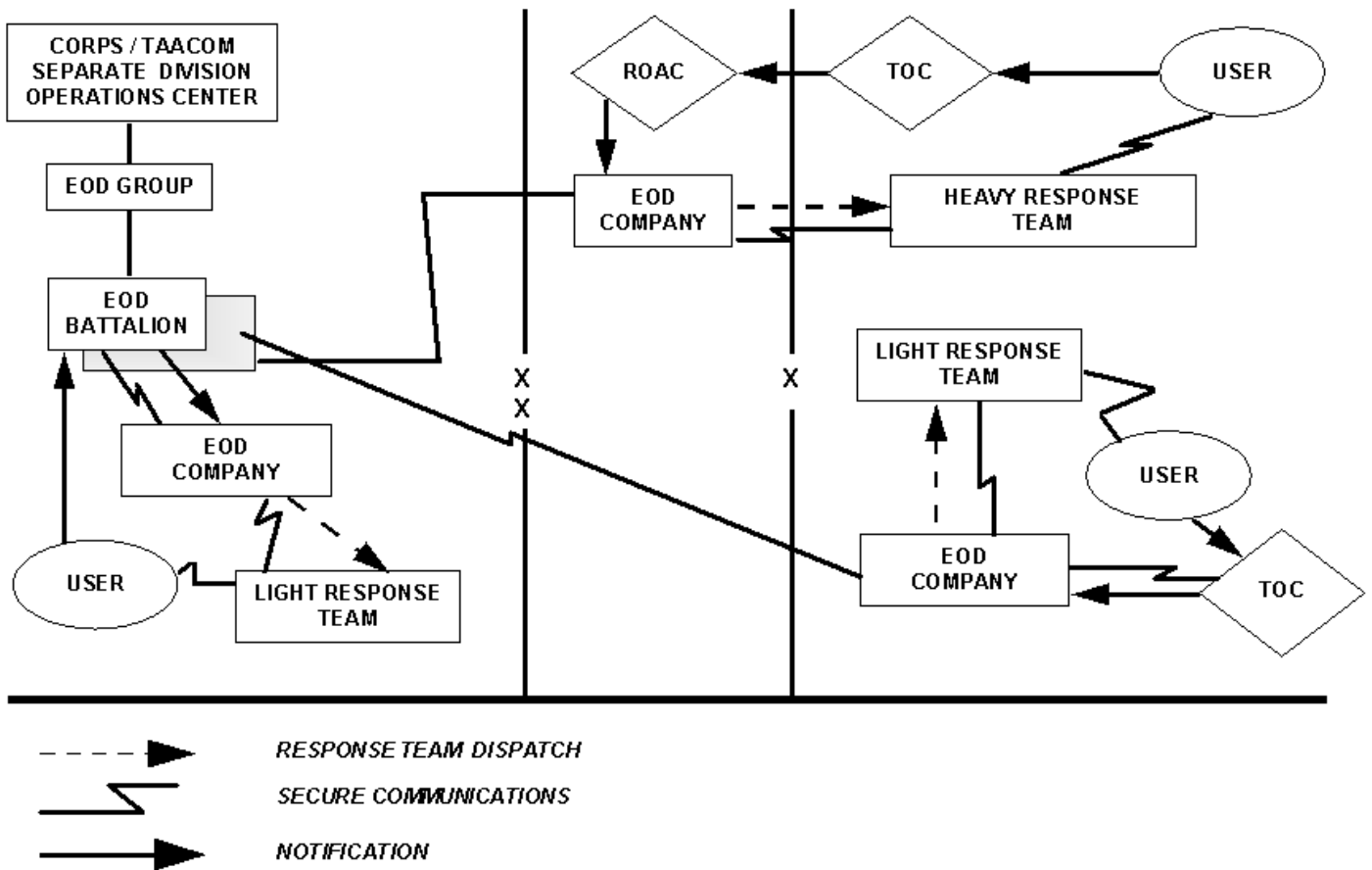

**Figure 5-2. Decentralized EOD incident reporting**

**EOD Battalion**

An EOD battalion provides command and control for three to ten EOD companies. A battalion with eight EOD companies is allocated to a TAACOM. A corps is allocated one EOD battalion with ten subordinate EOD companies.

The EOD battalion has a limited number of personnel and equipment. Therefore, it is dependent on the unit to which it is assigned or attached for rations and administrative and logistical support.

**Ordnance Group (EOD)**

The ordnance group (EOD) has two major functions: theater EOD planning and EOD command and control. This group is composed of two to six EOD battalions.

**User Level**

## **Support**

Any unit can report an EOD incident through operational or command channels to a central operations center. This center can be a DTOC, CTOC, or the TAACOM operations center.

The center's operations officer, with the assistance of the EOD staff officer, sets the priority of EOD incidents. Priority is based on the threat posed by the incident.

Incidents are coordinated, based on the operational mode used, through the EOD battalion or company for the assignment of an EOD response team. Lastly, the EOD response team is dispatched to the scene.

### **EOD Staff Officer**

The ranking EOD officer serves as the EOD staff officer to the TACOM, TAACOM, corps, or division. This officer is normally dual-hatted as the respective EOD group, battalion, or company commander.

Responsibilities of the EOD staff officer include the following:

- recommends policy and distribution of EOD assets.
- Monitors incident reports, establishes workload priorities, and serves as POC for technical intelligence coordination.
- Coordinates EOD support while ensuring that proper communications have been coordinated at each level supporting EOD operations.

The EOD staff officer and staff are located within the theater army command (TACOM), the TAACOM, the corps, and wherever a division is deployed as a separate unit. Also, an EOD staff element (joint service) will be located at the joint, unified, or combined command staff to assist in managing interservice EOD support.

If no ASCC staff headquarters exists in the theater of operations, an EOD officer and staff are included in the ARFOR element of a joint, unified, or combined command task force staff to manage Army EOD operations.

### **HOST NATION INTERFACE**

HN EOD assets generally have limited chemical or biological expertise and normally no capability for supporting nuclear weapons accidents or incidents. However, most HN forces do have an EOD identification capability. When US EOD support is not available, the area damage control cell of the RAOC interfaces with HN assets to use the appropriate HN EOD assets. If US EOD support is used, it must be properly coordinated and must comply with government, HN, state, and local requirements. If the HN does not have environmental laws and regulations, US statutes will apply. Emergency operations or EOD operations that take place during wartime will adhere to protocols as outlined in the Military Munitions Rule (MMR).

### **COMMUNICATIONS**

EOD units need a wide range of communications to accomplish their mission. Long-range communications are required among the deployed teams, the companies, the EOD battalion, and the EOD group. EOD units are linked to the area communications network through mobile subscriber equipment

(MSE). Also, EOD response teams and units require a data processing capability for electronic transmission of record traffic.

When operating at an incident site, EOD response teams need secure, short-range, wireless interteam communications for the coordination of team member activities and safety. The response teams dispatched on the battlefield require a position navigation device with digital data capability for precise location determination.

---

---

## Chapter 6

### THE ENVIRONMENT, SAFETY, RISK MANAGEMENT, AND MAINTENANCE AND SURVEILLANCE OPERATIONS

#### SECTION I. THE ENVIRONMENT

##### ENVIRONMENTAL POLICY AND GOALS

Much of the Army's environmental effort springs from the National Environmental Policy Act (NEPA), Public Law (PL) 91-190 of January 1970. NEPA requires federal officials to analyze potential environmental impacts of proposed actions and alternatives before making decisions. The law applies to all Army leaders and activities. Its purpose is to encourage harmony with our physical environment and promote efforts that prevent or eliminate environmental degradation. Also, it improves understanding of relations between ecological systems and important natural resources. In line with NEPA requirements, the Army established a number of policies, programs, and goals to preserve, protect, and restore the quality of our nation's environment.

The Army is also responsible for assisting and complying fully with HN, state, and local laws and regulations. Local laws and ordinances address the concerns of local communities. Each state has its own regulatory agency charged with developing and implementing environmental regulations. While many state and local regulations parallel federal law, they are often more stringent. The Army is committed to the policy that awareness and consideration of environmental issues are an integral part of our relations with the HN. (Note: In the event the HN has minimal or no environmental laws or regulations, [ARs 200-1](#) and [200-2](#) will apply).

Environmental stewardship calls for awareness and commitment throughout the Army. All soldiers and leaders must do their part by supporting Army objectives. The Army's environmental goals are as follows:

- Demonstrate leadership in environmental protection and improvement.
- Provide environmental awareness training, including training in environmental laws and regulations, for all soldiers.
- Ensure full compliance with federal, state, local, and HN laws.
- Ensure environmental concerns are part of the decision-making process at all levels of command.
- Provide guidance on the duties and responsibilities of unit commanders and individual soldiers as they relate to environmental stewardship, protection, and compliance.
- Ensure that environmental laws and regulations are followed with maximum emphasis on compliance.
- Incorporate unit-level procedures in SOPs at all command levels.

For added information on Army environmental stewardship, see [FM 20-400](#) (projected publication, FY 98).

Munitions and Army operations have the potential to cause considerable damage to the environment. Thus, the Army has become a national leader in the areas of environmental and natural resource stewardship. This role is an integral part of the Army mission for both present and future generations. Concurrent with this responsibility is the continuing need to exercise extreme caution to prevent accidental damage to the environment.

## STEWARDSHIP IN THE OPERATIONAL ENVIRONMENT

In day-to-day CONUS operations, or when coordinating operations within an HN or coalition scenario OCONUS, commanders must promote and inspire a keen awareness of the environment.

Many federal, state, local, and HN laws hold commanders legally responsible for environmental damage that is caused by inadequate planning or supervision of operations and training. Penalties can include fines or imprisonment or both.

To avoid adverse environmental impact when planning or executing operations, leaders must comply with the provisions of [ARs 200-1](#) and [200-2](#), [FM 20-400](#), 40 CFR, and the guidance for unit leaders contained in other appropriate manuals.

Providing ammunition in the theater of operations is essential. When doing so, however, leaders must follow applicable provisions of the Resource Conservation and Recovery Act (RCRA), to include the MMR. The RCRA establishes the framework for managing hazardous wastes. It sets the standards for hazardous waste identification, classification, transportation, storage, treatment, and disposal. When munitions or munitions operations fall under RCRA purview, full compliance includes requirements for permits and storage.

The operational commander determines the need for, and the environmental impact of, destruction of ammunition or other explosives. to prevent capture by the enemy, or injury to military or civilian personnel, operational requirements must be applied. Environmental considerations should be followed when time permits, especially if imminent and substantial danger to the environment exists.

Environmental damage that occurs as a result of enemy actions or accidents involving munitions should be repaired. Containment, cleanup, and restoration of the immediate area will allow the area to be used for future operations. Commanders must follow guidance in applicable publications and use environmental risk-assessment matrices to assess possible damage. Such assessments allow leaders to minimize environmental damage while optimizing performance and mission completion. Before conducting training, operations, or logistics activities, a risk-assessment matrix should be completed for each environmental area listed below:

- Air Pollution.
- Water pollution.
- Noise pollution.
- Archeological and historical sites.

Environmental Area (air pollution, water pollution, noise pollution, archeological and historic sites, hazardous materials and hazardous waste, threatened/endangered species, wetland protection).	Rating				
UNIT OPERATIONS	RISK IMPACT				
Movement of heavy equipment & vehicles	5	4	3	2	1
Movement of personnel & light vehicles/ systems	5	4	3	2	1
Assembly area activities	5	4	3	2	1
Field maintenance of equipment	5	4	3	2	1
Garrison maintenance of equipment	5	4	3	2	1

**Figure 6-1. Environmental risk-assessment matrix**

- Threatened/endangered species.
- Hazardous material and hazardous waste.
- Wetland protection.

See Figure 6-1 for an environmental risk-assessment matrix. [TC 5-400](#), Chapter 5, discusses risk management in depth and gives instructions on using the risk-assessment matrix.

Commanders of munitions and munitions support units have specific stewardship and compliance responsibilities. These go beyond the ones implicit in the Army's environmental goals. They include the following:

- Ensuring safety throughout the environment.
- Establishing a unit training program geared towards environmental considerations in handling ammunition.
- Preventing damage and pollution by ensuring existence and application of sound environmental procedures and practices in daily activities.
- Ensuring munitions are distributed and stored in a manner consistent with sound environmental

practices. This includes ensuring frequent inspections are conducted to detect deteriorating, leaking, or damaged containers.

- Ensuring compliance with environmental regulations during all operations.
- Focusing on prevention of pollution *at the source*, concurrent with the proper management of hazardous materials and hazardous waste.
- Focusing maximum attention on the prevention of environmental incidents and accidents by emphasizing proper training.
- Ensuring that an environmental compliance officer/hazardous waste coordinator is assigned in writing. This person must be properly trained and qualified in environmental matters. Duties should include coordination and interface with appropriate environmental personnel to ensure unit compliance with laws and regulations.

**Arming the force** is perhaps the most important of the five basic CSS functions. Effective and efficient distribution of munitions within a theater of operations *could be* the decisive factor in a battle or the war. Incorporating the environmental ethic and stewardship principles in day-to-day operations and ensuring compliance may seem at odds with this focus. What we must remember, however, is that where we operate and fight today may be where we work or live tomorrow.

## SECTION II. SAFETY RESPONSIBILITIES

Safety, including risk assessment (see Section III) and accident reporting, is an inherent responsibility of commanders at all levels. Its importance is intensified for units and personnel engaged in munitions-related activities. The following discussion provides guidance on both general and munitions-related safety issues.

Munitions handlers must be alert to the danger associated with depleted uranium rounds. Since these rounds present a potential radiological hazard, proper storage and handling are critical. See [TB 9-1300-278](#) for information on the hazards and appropriate safety measures.

All soldiers and leaders must maintain a proactive posture towards safety in day-to-day operations. This commitment to safety should be evident to seniors, peers, and subordinates. Specific responsibilities of key personnel and individuals are detailed below.

**Commanders.** Safety is a command responsibility at all echelons. Commanders must display active and aggressive leadership towards safety issues. They must appoint a safety officer or NCO IAW [AR 385-10](#) and [DA Pamphlet 385-1](#). They must determine the causes of accidents and take the necessary preventive and corrective measures.

**Safety Officer/NCO.** The primary duties and responsibilities of the unit safety officer or NCO include the following:

- Preparing a unit safety program and a field safety SOP focused on safety awareness (rather than reactive safety reporting).
- Reviewing regulations and Tms; recommending changes, when needed; recommending procedures for increasing safety in unit operations in general, as well as in the receipt, handling, storage, transporting, and issuing of munitions.
- Making safety-related suggestions to the commander for review and possible inclusion in unit SOPs.

**Leaders.** Leaders must ensure that soldiers perform their duties safely by-



- Making soldiers aware of hazards.
- Stressing safety in operations.
- Halting unsafe operations.
- Preventing accidents through pro-active planning and preparation.

**Individuals.** Individuals are largely responsible for ensuring their own safety. This includes:

- Familiarity with the Army's general safety policies for ammunition, explosives, and related operations (see [AR 385-64](#) and [TM 9-1300-206](#)).
- Knowledge of the basic principles of how munitions work and how to handle and transport them safely.
- Familiarity with hazards and safety precautions that apply to specific munitions. Such information can be found in FMs and TMs covering various types of munitions.

## **STANDING OPERATING PROCEDURES**

Each unit should have on hand a current, detailed (as much detail as needed) safety SOP. This safety SOP should include the following:

- Safety education and promotion plans.
- Safety requirements and training frequency.
- Procedures for detecting potential safety violations and ensuring that corrections are made.
- Provisions for periodic briefings conducted by the unit command to update soldiers on new munitions items and technical intelligence reports. This is an effective method of keeping soldiers informed and the safety awareness level high.

Individual SOPs must be developed for any and all operations where ammunition or explosives are involved. These procedures must describe the operation in enough detail to enable an untrained soldier to perform the operation safely. Failure to follow the SOP is the major cause of many accidents involving munitions. In some cases, no SOP was developed for the operation.

## **ACCIDENT REPORTING**

Besides recognizing and controlling safety hazards, it is essential that the causes of accidents be determined. This information aids in identifying accident trends, unsatisfactory work performance, personnel losses, and property damage. All accidents resulting in injury or property damage *must* be reported.

[DA Form 285](#) is the primary means of reporting accidents. For information on completing this form, see [AR 385-40](#).

When an accident occurs, it is important to gather all essential information for reports and possible corrective action. At a minimum, the following information should be included in the report:

- Who was injured or what was damaged.
- Time and place the accident occurred.
- Severity and cost (in personnel or materiel) of the accident.
- Nature of the accident or injury.
- How and why the accident occurred.

Corrective actions are based on specific facts about the accident or injury. They can include removing the hazards, improving operations, or training personnel. Moreover, corrective action must be supplemented by

proper management on the part of unit leaders. They must ensure that familiarity with operations does not lead to complacency or contempt for safety awareness.

## SECTION III. RISK ASSESSMENT AND MANAGEMENT

### INTEGRATING ASSESSMENT TECHNIQUES

In peacetime, leaders learn to assess risks during training exercises. Techniques learned in training can then be used during combat operations. In combat, risks must be taken, but only after the mission is evaluated and weighed as practiced during training.

Identification of hazards and their possible effects is called *risk assessment*. *Risk management* is the decision-making process that balances operational demands against identified risks. Doing risk assessment and applying risk management should become fully integrated parts of operational planning and execution.

### FIVE-STEP PROCESS

Risk management is a closed-loop, five-step process that can be used by anyone at any time or place and for any type of mission. The five steps are as follows:

- *Identifying the hazards*. Identify *all* hazards, including hazards to both soldiers and equipment.
- *Assessing the hazards*. Assess the hazards to determine the risks involved and their impact in terms of potential loss and cost. Assessments are based, to a degree, on probability and severity.
- *Developing controls and making risk decisions*. Develop control measures that eliminate hazards or reduce risks. Continually reevaluate risks during this process. The process continues until all risks are reduced to a level where the benefits outweigh potential costs.
- *Implementing controls*. Implement those controls that are determined to eliminate the hazards or reduce the risks.
- *Enforcing and reevaluating controls*. Enforce control measures through proper supervision. Constantly reevaluate the controls to ensure continuing effectiveness or to adjust as needed.

The proper use of risk assessment and risk management procedures is a primary force protection method. saving lives and protecting equipment from accidental damage and loss is the bottom line.

## SECTION IV. MAINTENANCE AND SURVEILLANCE OPERATIONS

### MAINTENANCE OPERATIONS

Maintenance of munitions includes all actions necessary to ensure that stocks are serviceable, or that unserviceable stocks are restored to a serviceable condition. Maintenance responsibilities are assigned to ammunition units based on the unit's primary mission and the availability of personnel, skills, time, tools, equipment, and supplies.

maintenance operations for DS units are based on METT-T. The preservation, pack-aging, marking, and minor spot painting of items is standard. situations calling for more than minor maintenance (i.e., PP) are handled and coordinated through command channels.

Ammunition maintenance planning must be aligned closely with the operational needs of the supported units. Maintenance planners must consider the availability of supplies and maintenance resources. A decrease in ammunition maintenance increases the amount of ammunition needed from the supply system.

Conversely, the inability of the supply system to replace unserviceable ammunition requires a greater maintenance effort. Proper maintenance, as well as the proper storage and handling, of ammunition increases readiness, reduces supply requirements for replacements, and conserves resources for other purposes. The maintenance planner must recognize the interdependence of maintenance and munitions support.

### **Concepts**

Combat units must have serviceable ammunition. Maintenance of munitions is a necessary and vital task that must be performed to maintain a high state of readiness. Maintenance includes minor operations (e.g., cleaning and rust removal) and major operations (e.g., complete renovation). Provisions must be made to conduct as much maintenance as possible at the storage location.

In some cases, ammunition must be evacuated for maintenance. However, since the movement of ammunition consumes transportation assets, it is inefficient to adopt a maintenance program geared totally to evacuation.

DS, GS, and modular units may initiate and conduct maintenance operations and programs when operating in the corps and theater areas. In these forward areas, maintenance functions are limited to PP operations, such as replacing broken banding or minor pallet repair or replacement.

### **Categories**

Munitions maintenance is divided into four categories: organizational, DS, GS, and depot. For ammunition units, DS and GS maintenance is limited to packaging and preservation operations.

**Organizational maintenance** is performed by all activities that have ammunition on hand, including using units. Organizational maintenance in the using unit is usually performed with the technical assistance of ammunition units.

**DS maintenance** is performed by ammunition companies in the theater of operations that have DS capabilities.

**GS maintenance** is performed by ammunition companies in the theater of operations that have GS capabilities. Modular companies are designed with the capability to perform both DS and GS maintenance.

If items require **depot maintenance** (such as modification, explosive component replacement, or complete renovation), the ammunition is packaged and evacuated to a depot.

All DS, GS, and modular companies with storage and issue missions are equipped to perform maintenance functions. Tools, equipment, and supplies needed to support maintenance are included in each unit's supply and equipment list.

### **Standing Operating Procedures**

All maintenance is performed IAW an approved maintenance SOP. See Tm 9-1300-250 for guidelines on preparing maintenance SOPs. Also, valuable guidance may be available from a unit with similar missions and responsibilities, or from experienced personnel. When local nationals are involved in maintenance operations, the SOP must be written in their language as well as in English.

### **SURVEILLANCE**

Ammunition surveillance is the observation, inspection, and classification of ammunition and its components during movement, storage, and maintenance operations. This definition also covers inspection equipment, facilities, and operations. Surveillance activities are conducted by all theater activities that store, maintain, dispose of, or ship ammunition and its components. Surveillance ends only when the ammunition is expended or destroyed.

The TAACOM is responsible for supervising ammunition surveillance in the theater of operations. The CSB or CSG closely supervises this function in its command. In established theaters of operation, surveillance activities are under the control of DA civilian (DAC) QASASs assigned to major Army headquarters. In theater ammunition units, surveillance is performed by attached civilians and assigned military inspectors.

The commander of any ammunition battalion must administer a QA ammunition surveillance program that covers all ammunition operations assigned to that command. The QASAS in charge has the overall responsibility for the program and reports directly to the commander. Since QASAS training is much more extensive than that of the military inspector, the QASAS performs the more complicated inspections and most functional tests. The QASAS certifies the results of any inspections or tests performed by the military inspectors. In some commands, certain inspection results and functional test reports can be signed only by a QASAS.

when in an immature or developing theater, all surveillance functions are performed by 55Bs in a DS, GS, or modular ammunition company.

### **Functions**

Ammunition inspectors perform the following duties:

- Inspect storage buildings, outdoor storage sites, and field storage sites to make sure that they comply with all storage standards.
- Inspect surrounding areas for fire hazards and other nonstandard conditions.
- Look for nonstandard conditions that could speed up the normal deterioration rate of the items in storage.
- Teach surveillance and ammunition safety.
- Prepare and maintain proper correspondence, records, and reports to cover all surveillance activities. See [SB 742-1](#) for a list of surveillance records and reports.
- Observe, inspect, and investigate to determine the current degree of serviceability of ammunition and components.
- Monitor the methods of storage, handling, and maintenance and recommend changes to increase safety and operational effectiveness.
- Recommend to commander controls needed to maintain standards of quality.
- Act as technical advisors to the commander on all ammunition surveillance matters.
- Inspect and investigate to determine the quality, safety, and deterioration of ammunition.
- Help investigate ammunition accidents.
- Help plan, coordinate, and administer the explosives safety program. This program includes review, evaluation, and inspection of all operations, procedures, equipment, and facilities used with ammunition and explosives operations to ensure application of and compliance with pertinent safety standards and criteria.
- Help plan the construction of storage facilities and/or field storage areas based on current

quantity-distance requirements and storage criteria.

- Prepare and maintain accurate records of all observations, inspections, and investigations.
- Maintain files and indexes for all drawings and specifications covering ammunition and methods of packing and storing.
- Inspect all incoming and outgoing shipments of ammunition for sabotage devices; proper blocking, bracing, and loading; condition and serviceability; and compliance with existing instructions and regulations.
- Inspect dunnage used and storage methods for compliance with specifications, drawings, and safety regulations.
- Furnish technical advice regarding safety to unit operating elements.
- Ensure all facilities and/or field storage areas comply with existing regulations. This includes compliance of the methods used to store, handle, ship, assemble, load, preserve, maintain, salvage, and destroy ammunition.
- Ensure all surveillance functions are performed IAW the procedures set forth in [SB 742-1](#), applicable TMs, and other SBs.

### **Inspections**

IAW [SB 742-1](#), the following surveillance inspections are performed by the QASAS and military inspectors:

- Receipt inspections, including depot transfers, field returns, and CEA.
- Periodic inspections (cyclic).
- Storage monitoring inspections.
- Special inspections.
- Pre-issue inspections.
- Verification inspections.
- Ammunition condition code inspections.

### **Serviceability Standards**

The object of an inspection is to find deterioration and determine the degree of serviceability of the inspected item. That is, whether the inspected item is serviceable as it stands, requires maintenance, or must be rejected. Before inspecting an item, the inspector should be familiar with all available information about the item, including its components, packaging, and the characteristics of the weapon in which it is used. See [SB 742-1](#) for serviceability standards references.

Inspection procedures include observation, physical tests (such as gauging or strength tests), and functional tests. Unserviceability can usually be detected by casual observation. As a general guide, munitions must not have any defects that would alter their characteristics, make them unsafe, or make them perform in any way other than for what they were designed. The inspector must determine whether defects found can be corrected and at what level this must be done.

The prime enemies of ammunition are heat and moisture. They affect all ammunition components to a varying degree. Deterioration is faster when moisture is combined with a rise in temperature. Inspectors should be especially alert to indications of moisture, rust, or corrosion on projectiles and fuses; corrosion and cracks on cartridge cases; deterioration of propellants; loose closing caps; and moisture or dampness inside containers.

### **Physical Defect**

## Standards

Evaluating the acceptability of materiel that shows deterioration or damage depends on the training, experience, and judgment of the inspector. The deterioration of materiel in storage is natural. However, the rate and degree of that deterioration vary according to the type of protective coating on the materiel, packaging, and storage conditions. Also, deterioration is progressive. If no maintenance is performed, the condition degrades through four stages: incidental, minor, major, and critical. The four stages are used to establish a uniform system of examination for deterioration or damage.

for added guidance on classifying metal, plastic, and rubber component deterioration; mixed ammunition; damaged packaging; and for placing defects into one of the four defect categories, see [SB 742-1](#), applicable technical manuals, and supply bulletins.

### Guided Missiles and Large Rocket Inspection

Guided missile and large rocket (GMLR) ammunition, components, propellants (liquid and solid), protective clothing, packaging, and packing materials are inspected and tested using applicable SBs, TMs, drawings, and specifications.

Most mid-size guided missiles are now certified as rounds and are maintained by the contractor at contractor facilities. Unit maintenance on guided missiles is essentially limited to spot-painting and replacement of wings, elevons, and the like. Inspectors must check with surveillance to determine those liquid propellants that should be removed before turn in. Missile items identified by lot or serial numbers are inspected for serviceability as follows:

- Materiel identified by lot number is sampled and inspected by individual lots. Missiles are inspected using the inspection table in the appropriate TM or SB.
- Materiel identified by serial number is put into homogeneous groups. This grouping is not a permanent or physical grouping of the items, but a grouping on paper for inspection. The judgment of a QASAS or MOS 55B ammunition specialist is needed in forming these groups.

Defects found in the sample are classified using the applicable SB, TM, or other specification. Where defects are not classified in these publications, the inspector classifies them according to [SB 742-1](#). The results of the sample inspection are used to make serviceability decisions about the lot or group.

### SURVEILLANCE RECORDS AND REPORTS

Surveillance personnel keep a technical history of each lot, serial number, or group of munitions. This history includes a record of the results of all inspections, tests, investigations, and any unusual or changing conditions affecting the items. These records are used to evaluate the serviceability and reliability of ammunition items. It is important that all information gathered from surveillance procedures is accurate and concise. The type of information needed for recording and reporting purposes may vary depending on the organizations supported by surveillance. The information needed to satisfy local and higher headquarters supply actions is determined by local procedures. The information needed for maintenance purposes is usually more detailed as to the extent of the defect and the work required to return the item to service. The following information is needed to evaluate the reliability of the stockpile:

- Condition.
- Quantity.

- Date of manufacture.
- Type of storage.
- Type of defects.
- Cause of defects.
- Results of tests.

Surveillance personnel are also required to submit other types of reports on materiel received or in storage and to maintain certain records. [SB 742-1](#) provides guidance for preparing these records and reports, which are listed below:

- [DD Form 250](#) (Material Inspection and Receiving Report).
- [DD Form 1575](#) (Suspended Tag-Materiel).
- [DD Form 1575-1](#) (Suspended Label-Materiel).
- [DD Form 1650](#) (Ammunition Data Card).
- [DA Form 984](#) (Munitions Surveillance Report Descriptive Data of Ammunition Represented by Sample).
- [DA Form 2415](#) (Ammunition Condition Report).
- [DA Form 3022-R](#) (Army Depot Surveillance Record).
- [DA Form 3023](#) (Gage Record).
- [DA Form 4508](#) (Ammunition Transfer Record).
- [SF 361](#) (Transportation Discrepancy Report).
- [SF 364](#) (Report of Discrepancy [ROD]).
- Ammunition inspection and lot number reports.
- Ammunition suspension records, to include Armament, Munitions, and Chemical Command (AMCCOM) and Missile Command (MICOM) suspension.
- Equipment logbooks and maintenance logs.
- Reports of explosions, chemical agent releases, serious accidents, and nuclear incidents.
- Small arms tracer reports.
- Storage monitoring records (local format).

### **DESTRUCTION PLAN**

The destruction of ammunition is based on METT-T and command guidance. A general plan for the destruction of unserviceable ammunition and CEA must be prepared for every storage activity. At a minimum, this plan includes the following:

- Priorities of materiel to be destroyed.
- Methods of destruction.
- Location of primary and alternate disposal sites.
- Protective clothing requirements.
- Decontamination requirements.
- Required equipment and explosive materials, with instructions for their placement and use.



Also, the destruction plan must consider emergency destruction of munitions. See Chapter 4 of this manual and [TM 43-0002-33](#) for more information on emergency destruction.

A destruction site should be carefully selected so that explosive fragments, debris, and toxic vapors do not become a hazard to personnel, materiel, facilities, or operations. For more information on selecting a destruction site, refer to [TM 9-1300-206](#) and [FMs 5-250](#) and [9-13](#).

Ammunition personnel normally perform the routine destruction of ammunition determined to be unserviceable as a result of damage or deterioration.

### **UNSERVICEABLE AMMUNITION STORAGE**

Unserviceable ammunition is either manufactured with defects or has been made unserviceable by improper storage, handling, packaging, or transportation. Shipments of ammunition received from other supply facilities should be inspected for serviceability. When it is not possible to inspect the ammunition at the time of receipt, unit turn ins should be stored in a segregated area for later inspection. Ammunition specialists should be familiar with indications of unserviceability and report them.

Unserviceable ammunition must be segregated from serviceable ammunition for safety reasons and to reduce rehandling. Also, inspectors must segregate the ammunition by DODIC and lot number, followed by serviceability classification. Ammunition that cannot be positively identified by lot number is automatically classified as pending disposition (condition code K). Exceptions may be made based on METT-T and the type, quantity, and condition of the ammunition.

The same safety precautions and principles used for storage of serviceable ammunition are used for the storage of unserviceable ammunition. Proper records must be kept on all unserviceable items stored at a supply facility.

Ammunition that requires maintenance should be segregated and marked to prevent issuing. Minor preservation and packaging are performed at field locations, TSAs, CSAs, or ASPs. Extensive maintenance is usually performed at a depot storage facility.

The unit packages and preserves the ammunition if that is the only requirement. If time permits, unserviceable ammunition that is repairable is retrograded for repair. Ammunition abandoned by using units is treated as unserviceable until it is inspected. The procedures that apply to unit turn-ins also apply to abandoned ammunition. Unserviceable ammunition is reported through proper channels for disposition instructions. Hazardous unserviceable ammunition is reported immediately through proper channels to EOD detachments for destruction. A demolition area is designated and cleared for the safe destruction of ammunition.

### **SUSPENDED AMMUNITION STORAGE**

Specific lots of ammunition and components are withdrawn from issue when they are determined to be unsafe or otherwise defective. Storing ammunition by lot number enables the rapid withdrawal from issue of those items that are unsafe, defective, or suspected of being defective.

The authority to suspend any lot of conventional ammunition is vested in the commander, Industrial Operations Command (IOC). However, a local suspension may be placed on a suspected lot of ammunition by the installation or area commander. A preliminary report, and later a detailed report, are forwarded through the supporting MMC to the ARFOR. The ammunition remains in local suspension unless its status is changed by higher headquarters. See [TB 9-1300-385](#) for instructions in preparing suspension reports. [TB 9-1300-385](#) lists



suspended lots of conventional ammunition and components. Added notices of suspensions or restrictions are produced as supplemental changes to [TB 9-1300-385](#), Ammunition Information Notices (AINS), or Safety of Use Messages (SOUMS).

Ammunition lots that are stored and later placed under suspension need not be moved to a segregated area unless the suspension notice so orders. Stacks of suspended ammunition must be clearly marked on all sides. This is done using [DD Form 1575](#) and [DA Form 3782](#), or facsimile-formatted documents (taped to the materiel), to show that the items have been suspended or restricted from issue. When foreign nationals are employed, locally-produced bilingual tags should be used. Suspended or restricted-issue items returned by the firing units, or items received from other supply facilities, should be segregated upon receipt. These items should be marked using the forms mentioned above and stored in the segregation area. [DA Form 3020-R](#) or a facsimile-formatted document (taped to the materiel) should be posted showing the suspension date, suspension number, and authority.

### **CAPTURED ENEMY AMMUNITION STORAGE**

Enemy ammunition found is considered excess and is to be treated as such. [AR 381-26](#) requires that one of three options be taken when ammunition is determined to be in excess for any reason on the battlefield. These options are *use, destroy, or secure and retrograde*. Except for use, all of these options apply to CEA. As discussed in this section, CEA includes all types of munitions.

When an enemy ammunition cache is found or captured, the commander must assess the combat situation. He must decide whether to destroy the CEA because of the situation, or to secure it and request EOD support. If the commander notifies EOD, he must provide the following information:

- Grid coordinates.
- Estimated quantity of munitions.
- Initial estimate of the different types of CEA in the cache.

EOD analyzes and identifies the types of munitions in the cache and determines the following:

- If the munitions present a hazard to friendly forces (booby-trapped or nuclear, biological, chemical [NBC]).
- If the items are safe to transport.

EOD then evaluates the CEA for possible technical intelligence exploitation. If any of the munitions are identified for technical exploitation, EOD forwards a technical intelligence report to the assistant chief of staff (intelligence) (G2/J2). The G2/J2 coordinates the evacuation of any of the CEA identified for exploitation. Also, civilian or military ammunition inspectors may assist in inspecting the cache after EOD has determined there are no extraordinary hazards (booby-traps, time-delay devices, and/or armed munitions). All hazardous enemy ammunition should be segregated and disposed of by trained personnel.

If the cache is to be retrograded, ammunition units in the corps are tasked to provide QASAS, MHE, and ammunition handlers to inspect, segregate, and load the captured stocks. Also, corps transportation assets are tasked to move the CEA. Working together, these corps assets load and transport the CEA to the designated ASA. Once the CEA arrives at the ASA, it is stored in a designated secure area separate from the area containing US munitions. Regardless of its condition, CEA cannot be intermingled with US munition stocks.

CEA that has been certified or cleared by EOD, QASAS, or military inspectors must be receipted, inspected,

and accounted for in the same way as US munitions. Once the CEA is identified as accurately as possible, it is entered into the SAAS-MOD system for accountability and control. This procedure must be done as soon as possible after receipt. Reporting and disposition instructions for CEA are the same as for friendly munitions. Close control of CEA is required.

Positively identified and serviceable CEA may be compatible for use in US or allied forces weapons systems. These munitions can greatly ease the burden on the ammunition supply system. Also, CEA can be used as a substitute for bulk explosives during demolition operations. See [FMs 9-13](#) and [9-15](#) for more information.

---

## APPENDIX

STANDARD ARMY AMMUNITION SYSTEM-  
MODERNIZATION (SAAS-MOD)

SAAS-MOD is an automated ammunition information system that integrates all three levels of operations into a single software baseline. The three levels are:

- Theater/corps materiel management center.
- Ammunition supply point.
- Division ammunition officer.

For a comparison between SAAS and SAAS-MOD, see Figure A-1.

The primary purpose of SAAS-MOD is to provide information regarding conventional ammunition assets to tactical commanders during wartime conditions. The system is used by all ammunition support activities in the Active and Reserve Components. SAAS-MOD manages all conventional ammunition, GMLR and their related components, as well as packaging materials. This automated system can pass and receive almost real-time information on all conventional munitions resources at the three levels of operations.

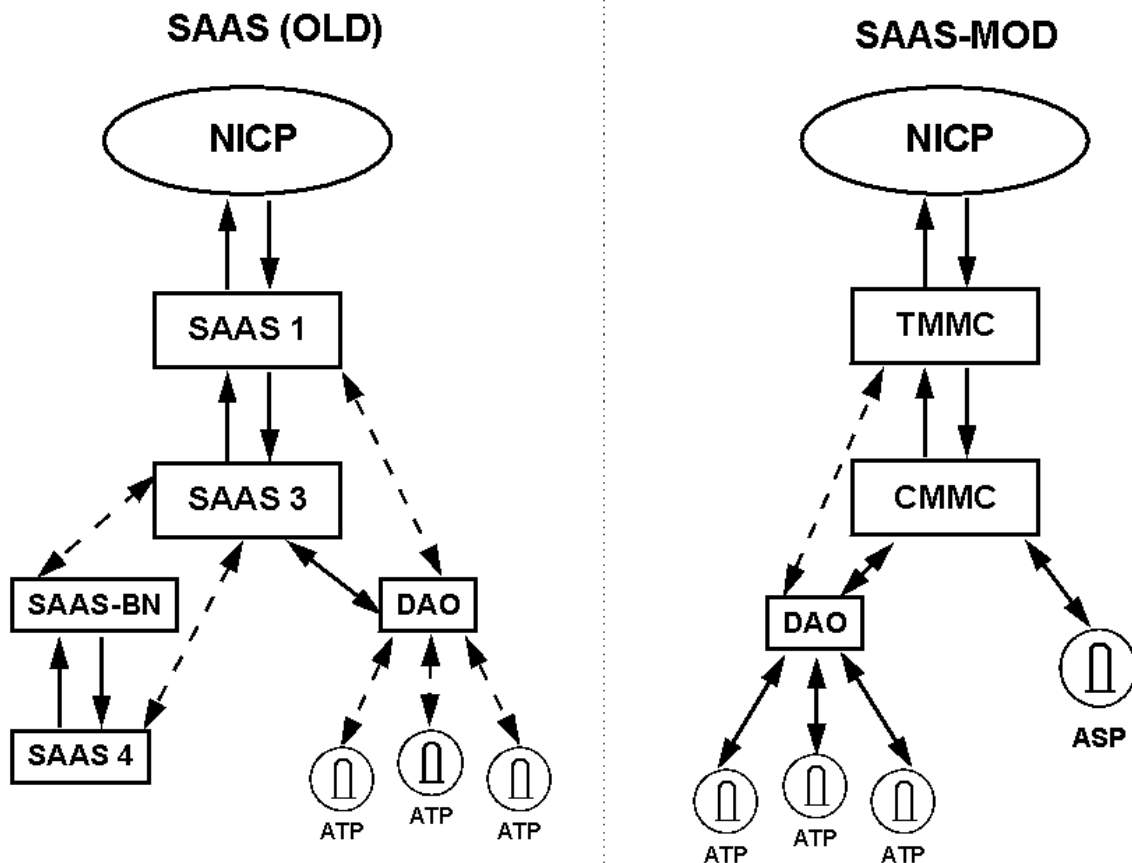

Figure A-1. SAAS versus SAAS-MOD

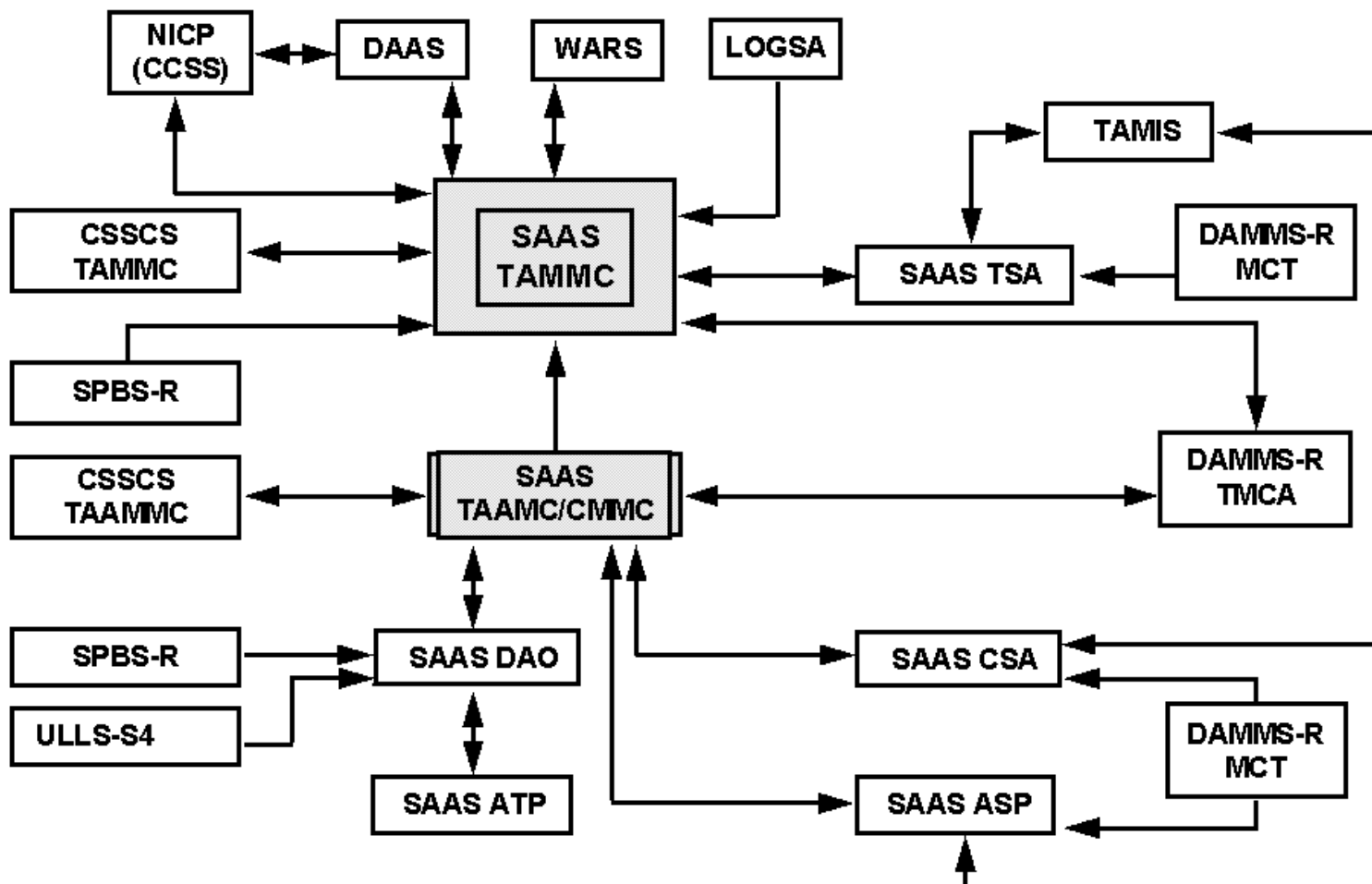

Figure A-2. SAAS-MOD interface

SAAS-MOD is a multicommand Stand-ard Army Management Information System (STAMIS) that integrates all retail munitions supply functions and processes. It does this using automated identification technology (AIT) such as RF tags and on desktop type computers, in a windows environment. It provides ITV and stock record accounting at the retail level.

Each SAAS-MOD operating level can function independently of the next higher level, if necessary. When deployed independently (such as with a modular ammunition platoon in an immature theater), SAAS-MOD can perform the functions of any level; for example, of a TAMMC. SAAS-MOD can also perform dual roles (CMMC/ TAMMC) during theater development (see Figure A-2). Functions include management of basic load, war reserve, and operational stocks. SAAS-MOD also gives users the ability to test wartime scenarios on existing data bases without disrupting real-time accountability.

SAAS-MOD can interface with the following systems:

- SAAS to SAAS.
- Commodity command standard system (CCSS).

- Logistics support activity (LSA).
  - Worldwide Ammunition Reporting System (WARS).
  - Standard Property Book System-Redesign (SPBS-R).
  - DA Movement Management System-Redesign (DAMMS-R).
  - Unit Level Logistics System, Level 4 (ULLS S-4).
  - Combat Service Support Control System (CSSCS).
-

## GLOSSARY

**ABL** - ammunition basic load

**ACofS** - Assistant Chief of Staff

**AINS** - Ammunition Information Notices

**airhead** - a designated location in an area of operations used as a base for supply and evacuation by air

**AIS** - Automated Information System(s)

**AIT** - automated identification technology

**AMCCOM** - armament munitions and chemical compound

**ammo** - ammunition

**ammunition basic load** - that quantity of conventional ammunition authorized and required to be on hand in a unit to meet combat needs until resupply can be accomplished; specified by the TA and expressed in rounds for ammunition items fired by weapons and in other units of measure for bulk allotment

**ammunition supply point** - an area designated to receive, store, and issue Class V materiel; normally located at or near the division area and operated by the corps DS ammunition company

**ammunition support activity** - generally, one of the storage areas (CSA/TSA/ASP) whose primary mission is to receive, store, issue, and maintain the theater's conventional ammunition stocks

**ammunition transfer point** - a designated temporary site where munitions are transferred from corps transportation to issuing unit vehicles; forward ATP is normally located in the brigade area, operated by either the supply company, FSB in a heavy division, the forward supply company of the S&T battalion in a light division, or the S&T company of the support battalion of a separate brigade; ammunition company ATP is normally located in the division area, operated by the ordnance company, ammunition (DS)

**AO** - area of operations

**APS** - Army prepositioned stocks

**AR** - Army regulation

**ARFOR** - Army force

**ASA** - ammunition support activity

**ASCC** - Army service component commander

**ASG** - area support group

**ASP** - ammunition supply point

**AST** - ammunition support team

**AT** - antitank

**ATP** - ammunition transfer point

**BB** - break-bulk

**BB/CON** - break-bulk/container

**BCT** - brigade combat train

**bde** - brigade

**bn** - battalion

**BSA** - brigade support area

**cbt** - combat

**CCSS** - commodity command standard system

**CEA** - captured enemy ammunition

**CINC** - commander in chief

**CL** - combat load

**CMCC** - corps movement control center

**CMMC** - corps materiel management center

**co** - company

**COMMZ** - communications zone

**controlled supply rate** - the rate of ammunition consumption that can be supported, considering availability, facilities, and transportation; expressed in rounds per unit, individual, weapon, or vehicle per day. The TA announces the CSR for each item of ammunition; in turn, the commander of each subordinate unit determines the CSR for the unit. A unit may not draw ammunition in excess of its CSR without authority from its next higher HQ. (*See* FM 101-10-1/2.)

**CONUS** - continental United States

**conv** - conventional

**convoy** - a group of vehicles organized for the purpose of control and orderly movement with or without escort protection

**corps storage area** - a site established to store and issue the ammunition requirements of the assigned or

attached corps combat units; operated by one or more GS ammunition companies. At least one CSA is needed to support a tactical division using the ASP and ATP network

**COSCOM** - corps support command

**CP** - command post

**CS** - combat support

**CSA** - corps storage area

**CSB** - corps support battalion

**CSG** - corps support group

**CSR** - controlled supply rate

**CSS** - combat service support

**CSSCS** - combat service support control system

**CTIL** - commander's tracked items list

**CTOC** - corps tactical operations center

**DA** - Department of the Army

**DAAS** - Defense Automated Addressing System

**DAC** - Department of the Army civilian

**DAMMS-R** - Department of the Army Movement Management System-Redesign

**DAO** - division ammunition officer

**DCSLOG** - Deputy Chief of Staff for Logistics

**DCSOPS** - Deputy Chief of Staff for Operations and Plans

**DD form** - Department of Defense form

**Department of Defense Identification Code** - an alphanumeric designation used to identify a specific item or component part of Class V materiel (for example, D544 is the DODIC for 155mm projectile, HE)

**devs** - developments

**dir** - director

**DISCOM** - division support command

**div** - division

**DLA** - Defense Logistics Agency

**DMMC** - division materiel management center



**DODIC** - Department of Defense Identification Code

**DOS** - days of supply

**DPG** - Defense Planning Guidance

**DS** - direct support

**DSA** - division support area

**DTO** - division transportation officer

**DTOC** - division tactical operations center

**DU** - depleted uranium

**EAC** - echelons above corps

**EOD** - explosive ordnance disposal

**EODCT** - explosive ordnance disposal control team

**EODTIC** - Explosive Ordnance Disposal Technical Information Center

**FM** - field manual

**FSB** - forward support battalion

**G2/J2** - Assistant Chief of Staff (Intelligence)

**G3** - Assistant Chief of Staff (Operations and Plans)

**G4** - Assistant Chief of Staff (Logistics)

**GMLR** - guided missile and large rocket

**GS** - general support

**HEMTT** - heavy expanded mobility tactical truck

**HHC** - headquarters and headquarters company

**HHD** - headquarters and headquarters detachment

**HLP** - heavy lift platoon

**HN** - host nation

**HNS** - host nation support

**HQ** - headquarters

**HQDA** - Headquarters Department of the Army

**IAW** - in accordance with

**ICM** - improved conventional munition

**IED** - improvised explosive device

**IOC** - Industrial Operations Command

**IPB** - intelligence preparation of the battlefield

**ISO** - International Standardization Organization

**ITV** - in-transit visibility

**JTF** - joint task force

**LAW** - light antitank weapon

**lift** - (of ammunition) the use of MHE to pick up ammunition and put it down, with each pickup and put-down constituting one lift. When containerized ammunition is received at the CSA or TSA, it is off-loaded with a rough-terrain container crane. The ammunition is unloaded with a variable-reach forklift and placed in a storage location. When issued, the ammunition is picked up by a rough-terrain forklift and placed on a vehicle. Each of these movements constitutes a lift, for a total of three lifts to receive, rewarehouse, and issue the ammunition

**LOC** - lines of communication

**LOGCAP** - Logistics Civilian Augmentation Program

**LOGSA** - logistics support activity

**LOTS** - logistics over-the-shore

**LPT** - logistics preparation of the theater

**LSA** - logistics support activity

**LSE** - logistics support element

**MACOM** - major Army command

**Maneuver-Oriented Ammunition Distribution System** - an ammunition supply system designed to provide 100 percent of combat units' (infantry, armor, field artillery, combat aviation, combat engineers, air defense artillery) ammunition requirements through the ATP network. Corps transportation (ground and air) is allocated and operates in a DS role to support ammunition shipments from the CSA to ASPs and ATPs, and from ASPs to ATPs

**MATO** - materiel office(r)

**MCA** - movement control agency

**MCC** - movement control center

**MCL** - mission-configured load

**METT-T** - mission, enemy, troops, terrain and weather, and time available

**MHE** - materials-handling equipment

**MICOM** - Missile Command

**mission-configured load** - ammunition configured/reconfigured into complete round mix/weapon system mix to meet a specific theater of operations requirement

**MLP** - medium-lift platoon

**MMC** - materiel management center

**MMR** - Military Munitions Rule

**MOADS** - Maneuver-Oriented Ammunition Distribution System

**MOADS-PLS** - MOADS-palletized load system

**MOD** - modernization

**MOS** - military occupational specialty

**MP** - military police

**MSB** - main support battalion

**MSE** - mobile subscriber equipment

**MTS** - movement tracking system

**NATO** - North Atlantic Treaty Organization

**NATO standardization agreement** - the record of an agreement among several member nations to adopt like or similar military equipment, ammunition, supplies, and stores and operational, logistic, and administrative procedures. National acceptance of a NATO allied publication issued by the Military Agency for Standardization may be recorded as a standardization agreement

**NBC** - nuclear, biological, chemical

**NCO** - noncommissioned officer

**NEPA** - National Environmental Policy Act

**NICP** - National Inventory Control Point

**NMP** - - National Maintenance Point

**OCONUS** - outside continental United States

**ODCSLOG** - Office of the Deputy Chief of Staff for Logistics

**ODCSOPS** - Office of the Deputy Chief of Staff for Military Operations and Plans

**OPCON** - operational control

**OPLAN** - operation plan

**OPLOG** - operational logistics

**OPORD** - operation order

**pam** - pamphlet

**PL** - public law

**PLS** - palletized load system

**POD** - port of debarkation

**POL** - petroleum, oils, and lubricants

**PP** - packaging and preservation

**push/pull system** - *push system*: the automatic resupply of ammunition consumed by the user; consumption rate is calculated by the type and quantity of ammunition issued to the user from stocks on hand at the issuing facility. Issues are reported through daily transaction reports to the CMMC by the issuing activity (such as an ASP, an ATP, or DAO). That quantity along with any new or additional requirements is pushed into the supply pipeline at the CSA or TSA to replenish or add to mission stocks forward. *Pull-system*: uses DAO requests for Class V by type and quantity to satisfy mission requirements

**QA** - quality assurance

**QASAS** - quality assurance specialist (ammunition surveillance)

**QC** - quality control

**RAOC** - rear area operations center

**RC** - Reserve Component

**RCRA** - Resource Conservation and Recovery Act

**required supply rate** - the quantity of ammunition expressed as rounds per weapon per day for ammunition items fired by weapons; as other units of measure per day, for bulk allotment and other items required to sustain operations of any designated force without restriction for a specified period

**RF** - radio frequency

**ROD** - report of discrepancy

**RSR** - required supply rate

**S3** - Operations and Training Officer

**S4** - Supply Officer

**SAAS** - Standard Army Ammunition System

**SAAS-MOD** - Standard Army Ammunition System-Modernization

**SASO** - stability and support operations

**SB** - supply bulletin

**SF** - standard form

**SFC** - sergeant first class

**short ton** - the equivalent of 2000 pounds (0.907 metric ton) of weight

**SITREP** - situation report

**sling out** - ammunition loaded into cargo nets and rigged beneath a helicopter. Sling-out operations are conducted primarily for emergency resupply of units not accessible by ground transport or when time or security is a critical factor

**SOP** - standing operating procedure

**SOUMS** - safety of use messages

**SPBS-R** - Standard Property Book System-Redesign

**spt** - support

**SRC** - standard requirement code

**ST/STON** - short ton

**STAMIS** - Standard Army Information System

**STANAG** - standardization agreement

**strategic configured load** - ammunition loaded into an ISO container or ISO-compatible flatrack at a CONUS depot or facility in a complete round mix for artillery and a weapon system mix for other systems (tanks, Bradleys, Apaches, etc)

**SUPCOM** - support command

**svc** - service

**TA** - theater army

**TAACOM** - theater army area command center

**TACOM** - theater army command

**TAMCC** - theater army movement control center

**TAMIS** - Training Ammunition Management Information System

**TAMMC** - theater army materiel management center

**TAV** - total asset visibility

**TB** - technical bulletin

**TC** - training circular

**tech** - technical

**theater storage area** - within the COMMZ, operated by one or more ordnance companies ammunition (GS); receives, stores, issues, and maintains the theater's conventional ammunition reserves; should be linked with air, road, rail, and seaborne networks and facilities when possible

**TM** - technical manual

**TMCA** - theater movement control agency

**TMMC** - theater materiel management center

**TOE** - table(s) of organization and equipment

**TPFD** - time-phased force deployment

**TRADOC** - US Army Training and Doctrine Command

**TRANSCOM** - transportation command

**TSA** - theater storage area

**ULLS-4** - Unit-Level Logistics System-S4

**US** - United States (of America)

**USACAA** - US Army Concepts Analysis Agency

**USACASCOM** - US Army Combined Arms Support Command

**USACASCOM&FL** - US Army Combined Arms Support Command and Fort Lee

**USAMC** - US Army Materiel Command

**USSS** - United States Secret Service

**UXO** - unexploded ordnance

**VIP** - very important person

**WARS** - Worldwide Ammunition Reporting System

**WD** - weapons density

**WHNS** - wartime host nation support

---

---

## REFERENCES

### SOURCES USED

The following sources are quoted or paraphrased in this publication.

AIS Manual 25-L6F-AJA-ZZZ-EM. *Standard Army Ammunition System Modernization (SAAS-MOD)*. 1 November 1995.\*

AR 75-15. *Responsibilities and Procedures for Explosive Ordnance Disposal*. 1 November - 1978.

AR 190-11. *Physical Security of Arms, Ammunition, and Explosives*. 30 September 1993.

AR 200-1. *Environmental Protection and Enhancement*. 23 April 1990.

AR 200-2. *Environmental Effects of Army Actions*. 23 December 1988.

AR 381-26. *(S) Army Foreign Materiel Exploitation Program (U)*. 27 May 1991.

AR 385-10. *The Army Safety Program*. 23 May 1988.

AR 385-40. *Accident Reporting and Records*. 1 November 1994.

AR 385-64. *Ammunition and Explosives Safety Standards*. 22 May 1987.

AR 710-1. *Centralized Inventory Management of the Army Supply System*. 1 February 1988.

AR 710-2. *Inventory Management Supply Policy Below the Wholesale Level*. 31 January 1992.

DA Pamphlet 385-1. *Small Unit Safety Officer/NCO Guide*. 22 September 1993.

[FM 5-250](#). *Explosives and Demolitions*. 15 June 1992.

[FM 9-13](#). *Ammunition Handbook*. 4 November 1986.

[FM 9-15](#). *Explosive Ordnance Disposal Service and Unit Operations*. 8 May 1996.

[FM 19-30](#). *Physical Security*. 1 March 1979.

FM 20-400. *Military Environmental Protection*. October 1996.

[FM 54-30](#). *Corps Support Groups*. 17 June 1993.

FM 55-2. *Division Transportation Operations*. 31 January 1985.

[FM 63-3](#). *Corps Support Command*. 30 September 1993.

[FM 63-4](#). *Combat Service Support Operations-Theater Army Area Command*. 24 September - 1984.

- [FM 63-11](#). *Logistic Support Element*. October 1996.
- [FM 100-5](#). *Operations*. 14 June 1993.
- [FM 100-7](#). *Decisive Force: The Army in Theater Operations*. 31 May 1995.
- [FM 100-10](#). *Combat Service Support*. 30 October 1995.
- [FM 100-16](#). *Army Operational Support*. 31 May 1995.
- [FM 100-27](#). *US Army/US Air Force Doctrine for Joint Airborne and Tactical Airlift Operations*. 31 January 1985.
- FM 101-10-1/2. *Staff Officers Field Manual-Organizational, Technical, and Logistical Data, Planning Factors (Volume 2)*. 7 October 1987.
- Military Munitions Rule. *Federal Register, 40 CFR, Part 260*. 12 February 1992.
- SB 742-1. *Ammunition Surveillance Procedures*. 12 November 1990.
- STANAG 2034 (Edition 4). *Land Forces Procedures for Allied Supply Transactions*. 20 December 1982.
- STANAG 2135 (Edition 3). *Procedures for Emergency Logistic Assistance*. 12 February 1982.
- STANAG 2827 (Edition 2). *Materials Handling in the Field*. 12 February 1980.
- STANAG 2829 (Edition 2). *Materials Handling Equipment*. 20 March 1978.
- STANAG 2834 (Edition 2). *The Operation of the Explosive Ordnance Disposal Technical Information Centre (EODTIC)*. 26 March 1990.
- STANAG 2928 (Edition 3). *Land Forces Ammunition Interchangeability Catalog in Wartime*. 9 June 1995.
- STANAG 2961 (Edition 1). *Classes of Supply of NATO Land Forces*. 11 December 1984.
- TB 9-1300-278. *Guidelines for Safe Response to Handling, Storage, and Transportation Accidents Involving Army Tank Munitions or Armor Which Contain Depleted Uranium*. 21 July 1996.
- TB 9-1300-385. *Munitions Restricted or Suspended*. 1 September 1996.
- [TC 5-400](#). *Unit Leaders' Handbook for Environmental Stewardship*. 29 September 1994.
- TM 9-1300-206. *Ammunition and Explosives Standards*. 30 August 1973.
- TM 9-1300-250. *Ammunition Maintenance*. 25 September 1969.
- TM 43-0002-33. *Destruction of Conventional Ammunition and Improved Conventional Munitions (ICM) to Prevent Enemy Use*. 15 November 1993.
- TOE 09408L000. *HQs, Modular Ammo Ordnance Company*.
- TOE 09433L000. *Ordnance Company, Ammo PLS/MOADS, CSA*.



*TOE 09483L000. Ordnance Company, Ammo (MOADS) DS.*

*TOE 09484L000. Ordnance Company, Ammo DS (PLS/MOADS).*

*TOE 09488L000. Ordnance Company, Ammo, Conv, GS.*

*TOE 09503LA00. Modular Ammo Ordnance, Medium Lift Platoon.*

*TOE 09503LB00. Modular Ammo Ordnance, Heavy Lift Platoon.*

*TOE 09662L000. HHD, Ordnance Group, Ammo.*

*TOE 09666L000. HHD, Ordnance Battalion (Ammo) DS/GS.*

*Unit Supply Update 2-14. 28 February 1994..*

### **DOCUMENTS NEEDED**

*The following documents must be available to the intended users of this publication.*

*DA Form 285. U.S. Army Accident Report. January 1992.*

*DA Form 984. Munition Surveillance Report Descriptive Data of Ammunition Represented by Sample. June 1980*

*DA Form 2028. Recommended Changes to Publications and Blank Forms. 1 February 1974.*

*DA Form 2415. Ammunition Condition Report. 1 December 1977.*

*DA Form 3020-R. Magazine Data Card. August 1989.*

*DA Form 3022-R. Army Depot Surveillance Record. May 1990.*

*DA Form 3023. Gage Record. 1 July 1965.*

*DA Form 3782. Suspended Notice. September 1971.*

*DA Form 4508. Ammunition Transfer Record. May 1976.*

*DD Form 250. Materiel Inspection and Receiving Report. November 1992.*

*DD Form 1575. Suspended Tag Materiel. October 1966.*

*DD Form 1575-1. Suspended Label Materiel. 1 October 1966.*

*DD Form 1650. Ammunition Data Card. September 1986.*

*SF Form 361. Transportation Discrepancy Report. March 1984.*

*SF Form 364. Report of Discrepancy (ROD). February 1980.*

### **READINGS RECOMMENDED**

*The following readings contain relevant supplemental information.*

- AR 11-11. (C) War Reserves (U). 1 June 1985.*
- AR 40-13. Medical Support Nuclear/Chemical Accidents and Incidents. 1 February 1985.*
- AR 40-14. Occupational Ionizing Radiation Personnel Dosimetry. 30 June 1995.*
- AR 50-5. Nuclear and Chemical Weapons and Material Nuclear Surety. 3 October 1986.*
- AR 50-5-1. (C) Nuclear Weapon Security. 1991.*
- AR 50-6. Nuclear and Chemical Weapons and Material, Chemical Surety. 1 February 1995.*
- AR 55-203. Movement of Nuclear Weapons, Nuclear Components, and Related Classified Nonnuclear Materiel. 31 October 1974.*
- AR 55-228. Transportation by Water of Explosives and Hazardous Cargo. 30 April 1969.*
- AR 55-355. Defense Traffic Management Regulation. 31 July 1986.*
- AR 75-1. Malfunctions Involving Ammunition and Explosives. 20 August 1993.*
- AR 190-13. The Army Physical Security Program. 30 September 1993.*
- AR 190-40. Serious Incident Report. 30 November 1993.*
- AR 190-51. Security of Unclassified Army Property (Sensitive and Nonsensitive). 30 September 1993.*
- AR 190-59. Chemical Agent Security Program. 27 June 1994.*
- AR 380-67. The Department of the Army Personnel Security Program. 9 September 1988.*
- AR 385-11. Ionizing Radiation Protection (Licensing, Control, Transportation, Disposal, and Radiation Safety). 1 May 1980.*
- AR 725-50. Requisition, Receipt, and Issue System. 15 November 1995.*
- AR 735-5. Policies and Procedures for Property Accountability. 28 February 1994.*
- DA Pamphlet 710-2-1. Using Unit Supply System (Manual Procedures). 1 January 1982.*
- [FM 3-100](#). *Chemical Operations Principles and Fundamentals. 8 May 1996.*
- [FM 5-100](#). *Engineer Operations. 27 February 1996.*
- [FM 6-20](#). *Fire Support in the AirLand Battle. 17 May 1988.*
- [FM 7-30](#). *The Infantry Brigade. 3 October 1995.*
- [FM 9-38](#). *Conventional Ammunition Unit Operations. 2 July 1993.*
- FM 9-59. Maintenance Operations for Air Defense and Land Combat Weapons Systems. 8 March 1994.*
- [FM 10-27](#). *General Supply in Theaters of Operations. 20 April 1993.*

[FM 10-27-2](#). *Tactics, Techniques, and Procedures for Quartermaster Direct Support Supply and Field Service Operations*. 18 June 1991.

[FM 10-67](#). *Petroleum Supply in Theaters of Operations*. 16 February 1983.

[FM 19-1](#). *Military Police Support for the AirLand Battle*. 23 May 1988.

[FM 21-16](#). *Unexploded Ordnance (UXO) Procedures*. 30 August 1994.

[FM 24-1](#). *Signal Support in the AirLand Battle*. 15 October 1990.

[FM 41-10](#). *Civil Affairs Operations*. 11 January 1993.

[FM 43-5](#). *Unit Maintenance Operations*. 28 September 1988.

[FM 43-11](#). *Direct Support Maintenance Operations (Nondivisional)*. 5 September 1991.

[FM 43-12](#). *Division Maintenance Operations*. 10 November 1989.

[FM 43-20](#). *General Support Maintenance Operations*. 10 November 1989.

[FM 44-100](#). *US Army Air Defense Operations*. 15 June 1995.

[FM 54-23](#). *Materiel Management Center, Corps Support Command*. 28 December 1984.

[FM 54-40](#). *Area Support Group*. 3 October 1995.

[FM 55-450-2](#). *Army Helicopter Internal Load Operations*. 5 June 1992.

[FM 55-450-3](#). *Multiservice Helicopter External Air Transport: Basic Operations and Equipment*. 11 February 1991.

[FM 55-450-4](#). *Multiservice Helicopter External Air Transport: Single-Point Rigging Procedures*. 11 February 1991.

[FM 55-450-5](#). *Multiservice Helicopter External Air Transport: Dual-Point Load Rigging Procedures*. 11 February 1991.

[FM 63-1](#). *Support Battalions and Squadrons, Separate Brigades and Armored Cavalry Regiment*. 30 September 1993.

[FM 63-2](#). *Division Support Command, Armored, Infantry, and Mechanized Infantry Divisions*. 20 May 1991.

[FM 63-20](#). *Forward Support Battalion*. 26 February 1990.

[FM 63-21](#). *Main Support Battalion*. 7 August 1990.

[FM 71-100](#). *Division Operations*. 28 August 1996.

[FM 90-2](#). *Battlefield Deception*. 3 October 1988.

[FM 100-15](#). *Corps Operations*. 29 October 1996.

[FM 100-17-1](#). *Army Pre-Positioned Afloat Operations*. 27 July 1996.

[FM 100-20](#). *Military Operations in Low Intensity Conflict*. 5 December 1990.

*FM 101-10-1/1*. *Staff Officers Field Manual Organizational, Technical and Logistical Data (Volume One)*. 7 October 1987.

*SB 38-26*. (C) *Nonnuclear Ammunition Supply Rates (U)*. 20 April 1979.

*TM 3-250*. *Storage, Shipment, Handling, and Disposal of Chemical Agents and Hazardous Chemicals*. 7 March 1969.

*TM 5-315*. *Firefighting and Rescue Procedures in Theaters of Operations*. 20 April 1971.

*TM 38-L06-10*. *Logistics Information System Overview Standard Army Ammunition System (SAAS)*. 1 May 1980.

*TM 38-L06-11-1*. *Functional Users Manual for Standard Army Ammunition System-1 (SAAS-1): Functional Procedures*. 1 October 1980.

*TM 38-L06-11-2*. *Functional Users Manual for Standard Army Ammunition System-1 (SAAS-1): Appendixes A, B, and C*. 1 October 1980.

*TM 38-L06-11-3*. *Functional Users Manual for Standard Army Ammunition System-1 (SAAS-1): Appendixes D thru J*. 1 October 1980.

*TM 38-L69-11*. *Standard Army Ammunition System (SAAS) Level 4 Manual: System Stock Control Procedures*. 30 September 1983.

## **PROJECTED PUBLICATIONS**

*The following manuals are scheduled for publication during the fiscal year specified:*

*FM 9-20*. *Technical Escort Operations*. FY 97 (supercedes TC 9-20, *Technical Escort - Operations*, 3 October 1988.)

*FM 20-400*. *Military Environmental Protection*. FY 98.

---

*\* Request copies of the AIS manual through:*

*CDR USAISSDCL  
ATTN ASQB ILA C  
10500 A AVENUE  
FORT LEE VA 23801-6065*

---

FM 9-6  
20 MARCH 1998

By Order of the Secretary of the Army:

Official:

  
JOEL B. HUDSON

*Administrative Assistant to the  
Secretary of the Army*

04380

DENNIS J. REIMER  
*General, United States Army  
Chief of Staff*

DISTRIBUTION:

Active Army, Army National Guard, and US Army Reserve: To be distributed in accordance with the initial distribution number 110087, requirements for FM 9-6.

**PIN: 023665-000**